

M3302A PXIe Arbitrary Waveform Generator and Digitizer with Optional Real-Time Sequencing and FPGA Programming

500 MSa/s, 16 Bits, 2 Channel Arbitrary Waveform Generator
500 MSa/s, 14 Bits, 2 Channel Digitizer



Fast, Flexible, High-Performance Control, Testing and Prototyping

The M3302A combines high-performance arbitrary waveform generator channels and digitizer channels in the same module providing the ideal tool for testing and prototyping in control or communications applications. Performance meets simplicity thanks to easy-to-use programming libraries, real-time sequencing technology (Hard Virtual Instrumentation or HVI), and graphical FPGA programming technology.

Features

Outputs (AWG)

- 500 MSa/s, 16 Bits, 2 Channels

Inputs (digitizer)

- 500 MSa/s, 14 Bits, 2 Channels

Output features

- AWGs, function generators, AM/FM/PM modulators
- Advanced triggering and marking functionalities

Input features

- Powerful data acquisition system (DAQ)
- Advanced triggering and marking functionalities

Less than 400 ns input to output latency

Optional HW programming for high-performance applications

- Real-time sequencing (HVI technology)
- FPGA programming
 - Xilinx Kintex-7K410T FPGA

Up to 2 GB of onboard RAM (~ 1 Gsamples)

Mechanical/interface

- 2 slots 3U (PXIe)
- PCIe Gen 2
- Independent DMA channels for fast and efficient data transfer

Applications

General purpose AWGs and digitizers

High-performance control

Communications: BB/IF SDR, channel emulation, transceiver testing

Aerospace and defense (A/D): RADAR, electronic warfare (EW)

Hardware-in-the-loop (HIL), automated test equipment (ATE)

Scientific research

Quantum computing

Functional Block Diagram

Output - Arbitrary Waveform Generator

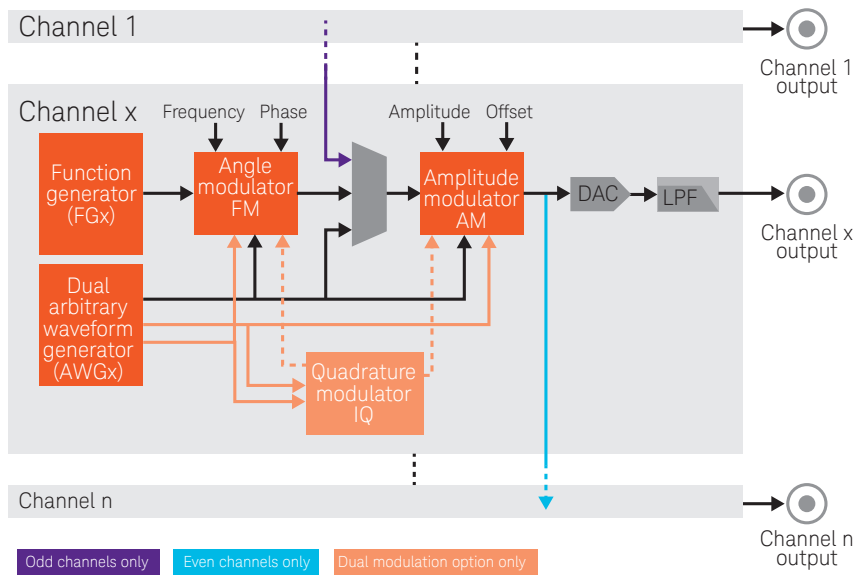

Figure 1. M3302A output functional block diagram, all channels have identical output structure

Input - Digitizer

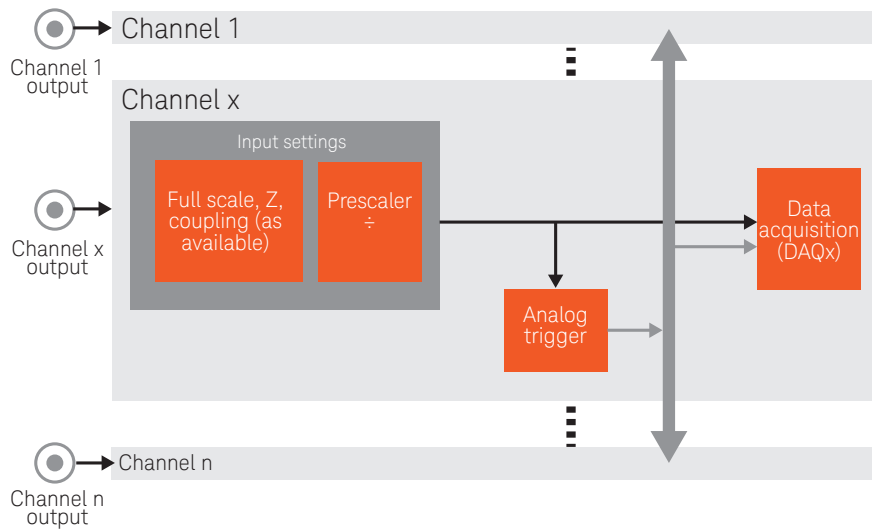

Figure 2. M3302A input functional block diagram, all channels have identical input structure

Programming Technology and Software Tools

Software programming

- Easy-to-use native programming libraries for most common languages: C, C++, Visual Studio, LabVIEW, MATLAB, Python

Hardware programming (optional)

- Real-time sequencing (Hard Virtual Instrumentation or HVI technology)
 - Graphical flowchart-style M3601A design environment (-HV1 option required on HW)
 - Ultra-fast, fully-parallelized, hard real-time execution
 - Ultra-fast, time-deterministic decision-making
 - Off-the-shelf inter-module synchronization and data exchange
- FPGA programming
 - FPGA design environment and BSP support
 - Supports VHDL, Verilog and Xilinx projects, and Xilinx IP Catalog
 - Ultra-fast, one-click compiling and on-the-fly programming

SD1 2.x and SD1 3.x differences

Keysight SD1 2.x software has been upgraded to 3.x. The key differences are listed in the table below. For more detail on SD1 3.x software, refer to the Start Up Guide M3xxx-90002.

[WARNING] The 3.X version of software does not support programs using the M3601A or the M3602A applications. You will have to transition to KS2201A and KF9000A respectively.

SD1 software features	Legacy (SD1 2.1.x)	New (SD1 3.x)
Software		
Design Environment	M3601A HVI design environment (ProcessFlow) M3602A FPGA design environment (FPGAFlow)	KS2201A PathWave Test Sync Executive (HVI2 technology) KF9000A PathWave FPGA Programming Environment (commonly known as PathWave FPGA)
HVI Technology	<ul style="list-style-type: none"> – Graphical M3601A for HV1 – HVI-C API (through SD1 installer) 	KS2201A PathWave Test Sync Executive (HVI2 Core API through a separate HVI installer)
FPGA Programming	<ul style="list-style-type: none"> – Graphical M3602A – PathWave FPGA (BSP for SD1 2.1.x only) 	PathWave FPGA (BSP installer for each supported module is required)
Soft Front Panel (SFP)	Available	Available
Programming Interface	Python, C++, C#, LabVIEW, MATLAB	Python, C, C++, C#
Supported Operating System	Windows 10	Windows 10
Hardware Modules		
M3202A (AWG 1G)	FW version<4.0 (CH4) (CLF) (K16, K32, K41) BSP available (K32, K41)	FW version>=4.0 (CH4) (CLF) (K16, K32, K41) BSP available (K32, K41)
M3201A (AWG 500)	FW version<4.0 (CH4) (CLF) (K16, K32, K41) BSP available (K32, K41)	FW version>=4.0 (CH4) (CLF) (K16, K32, K41) BSP available (K32, K41)
M3102A (DIG 500)	FW version<2.0 (CH4) (CLF) (K16, K32, K41) BSP available (K32, K41)	FW version>=2.0 (CH4) (CLF) (K16, K32, K41) BSP available (K32, K41)
M3100A (DIG 100)	FW version<2.0 (CLF) (CH4 or CH8) (K16, K32, K41) BSP available (K32, K41)	FW version>=2.0 (CLF) (CH4) (K32, K41) BSP not available
M3302A (COMBO 500 500)	FW version<4.0 (CLF) (CH2 AWG - CH2 DIG) (K32, K41) BSP available (K32, K41)	FW version>=4.0 (CLF) (CH2 AWG - CH2 DIG) (K41) BSP not available
M3300A (COMBO 500 100)	FW version<4.0 (CLF) (CH2 AWG - CH4 DIG or CH4 AWG - CH8 DIG) (K32, K41) BSP available (K32)	FW version>=4.0 (CLF) (CH2 AWG - CH4 DIG) (K41) BSP not available

No programming

Easily configurable SD1 SFP (software front panel) interface for each connected module

PXIe Arbitrary Waveform Generators, Digitizers and Combination Modules

Product	Type	Outputs (AWGs)				Inputs (Digitizers)			
		Speed (MSa/s)	Bits	Ch	BW (MHz)	Speed (MSa/s)	Bits	Ch	BW (MHz)
M3202A	AWG	1000	14	4	400				
M3201A	AWG	500	16	4	200				
M3102A	Digitizer					500	14	4	DC-200
M3100A	Digitizer					100	14	4/8	DC-100
M3302A	Combo	500	16	2	200	500	14	2	DC-200
M3300A	Combo	500	16	2/4	200	100	14	4/8	DC-100

Note: For SD1 3.x M3100A and M3300A only come in a 4 channel Digitizer version. And M3300A in the 2 channel AWG version.

AWG Technical Specifications and Characteristics

General characteristics

M3302A-C22					
Parameter	Min	Typ	Max	Units	Comments
Inputs and outputs					
Channels (single-ended mode)		2		Out	
Channels (differential mode)		1		Out	Differential uses 2 channels
Reference clock ¹		1		Out	
Reference clock ²		1		In	
Triggers/markers ^{1,3}		1		In/out	Reconfigurable
Triggers/markers ^{2,3}		8		In/out	Reconfigurable
Output channels overview					
Sampling rate ⁴	0.005		500	MSa/s	
Voltage resolution		16		Bits	
Output frequency	DC		200	MHz	
Real-time BW			200	MHz	
Output voltage	-1.5		1.5	Volts	
Built-in functionalities					
Function generators		2			1 per channel
Dual AWGs		2			1 per channel
IQ modulators		2			1 per channel
Frequency modulators		2			1 per channel
Phase modulators		2			1 per channel
Amplitude modulators		2			1 per channel
DC offset modulators		2			1 per channel
Onboard memory					
RAM memory	16		2048	MBytes	

1. At front panel.
2. At backplane.
3. Markers available from firmware version v3.0 or later.
4. (-CLV) option: DC to 500 MSa/s; (-CLF) option: fixed 500 MSa/s.

I/O specifications

Parameter	M3302A-C22			Units	Comments
	Min	Typ	Max		
Output channels					
Sampling rate ¹	100		500	MSa/s	
Output frequency	0		200	MHz	Limited by a reconstruction filter
Output voltage	-1.5		1.5	Volts	On a 50 Ω load
Source impedance		50		Ω	
Reference clock output					
Frequency		10 to 12.5 ²		MHz	Generated from the internal clock, user selectable
Voltage		800		mV _{pp}	On a 50 Ω load
Power		2		dBm	On a 50 Ω load
Source impedance		50		Ω	AC coupled
External I/O trigger/marker					
V _{IH}	2		5	V	
V _{IL}	0		0.8	V	
V _{OH}	2.4		3.3	V	On a high Z load
V _{OL}	0		0.25	V	On a high Z load
Input impedance		10		K Ω	
Source impedance		TTL		-	
Speed		100		MHz	

1. (-CLV) option: 100 to 500 MSa/s; (-CLF) option: fixed 500 MSa/s.
2. CLF option is set to 10 MHz while with CLV option varies from 12.5 MHz to 10 MHz.

Function generators (FGs) specifications

Parameter	M3302A-C22			Units	Comments
	Min	Typ	Max		
General specifications					
Function generators		2		-	1 per channel
Waveform types		4		-	Sinusoidal, triangular, square and DC
Frequency range	0		200	MHz	
Frequency resolution		45		Bits	
Frequency resolution		5.7		μHz	
Phase range	0		360	Deg	
Phase resolution		24		Bits	
Phase resolution		21.5		μdeg	
Speed performance					
Frequency change rate		100		MChanges/s	With HVI technology
Frequency modulation rate		500		MSamples/s	With AWGs and angle modulators
Phase change rate		100		MChanges/s	With HVI technology
Phase modulation rate		500		MSamples/s	With AWGs and angle modulators

Amplitude and offset specifications

Parameter	M3302A-C22			Units	Comments
	Min	Typ	Max		
General specifications					
Amplitude/offset range	-1.5		1.5	Volts	Amplitude + offset values
Amplitude/offset resolution		16		Bits	
Amplitude/offset resolution		45.8		μV	
Speed performance					
Amplitude/offset change rate		500		MChanges/s	With HVI technology
Amplitude/offset modulation rate		500		MSamples/s	With AWGs and amplitude modulators

Arbitrary waveform generators (AWGs) specifications

Parameter	M3302A-C22			Units	Comments
	Min	Typ	Max		
General specifications					
Dual AWGs		2			1 Dual AWG per output channel
Aggregated speed (16 bits)			2000	MSa/s	For all onboard waveforms combined
Aggregated speed (32 bits)			1000	MSa/s	For all onboard waveforms combined
Waveform multiple		5		Samples	Waveform length must be a multiple of this value
16-bit waveform length	65		957M	Samples	Maximum depends on onboard RAM
32-bit waveform length	65		478M	Samples	Maximum depends on onboard RAM
Waveform length efficiency		93.5		%	Effic. = waveform size/waveform size in RAM
Trigger		Select			External Trigger (input connector, backplane triggers), SW/HVI trigger
AWG specifications (16-bit single waveform)					
Speed			500	MSa/s	Per AWG
Resolution		16		Bits	
AWG destination		Select			Amplitude, offset, frequency or phase
AWG specifications (16-bit dual waveform)					
Speed (waveform A)			500	MSa/s	Per AWG
Speed (waveform B)			500	MSa/s	Per AWG
Resolution (waveform A)		16		Bits	
Resolution (waveform B)		16		Bits	
AWG destination (waveform A)		Select			Amplitude and offset or I and Q control outputs on channels 1,2
AWG destination (waveform B)		Select			Frequency and phase or I and Q readouts on channels 3,4

Angle modulators specifications

Parameter	M3302A-C22			Units	Comments
	Min	Typ	Max		
General specifications					
Frequency modulators	2				1 per output channel
Phase modulators	2				1 per output channel
Carrier signal source	FGs				refer FG specifications table in this document
Modulating signal source	AWGs				refer AWG specifications table in this document
Frequency modulators (16-bit modulating waveform)					
Deviation	-Dev. gain		+Dev. gain	MHz	
Modulating signal resolution	16			Bits	AWG waveform
Modulating signal BW	0		250	MHz	AWG Nyquist limit
Deviation gain	0		200	MHz	
Deviation gain resolution	16			Bits	
Phase modulators (16-bit modulating waveform)					
Deviation	-Dev. gain		+Dev. gain	Deg	
Modulating signal resolution	16			Bits	AWG waveform
Modulating signal BW	0		250	MHz	AWG Nyquist limit
Deviation gain	0		180	Deg	
Deviation gain resolution	16			Bits	~ 5.5 mdeg

Amplitude modulators specifications

Parameter	M3302A-C22			Units	Comments
	Min	Typ	Max		
General specifications					
Amplitude modulators		2			1 per output channel
Offset modulators		2			1 per output channel
Carrier signal source		FGs			refer FG specifications table in this document
Modulating signal source		AWGs			refer AWG specifications table in this document
Amplitude and offset modulators (16-bit modulating waveform)					
Deviation	-Dev. gain		+Dev. gain	V_p	
Modulating signal resolution		16		Bits	AWG waveform
Modulating signal BW	0		250	MHz	AWG Nyquist limit
Deviation gain	0		1.5	V_p	
Deviation gain resolution		16		Bits	Limited by the output DAC

IQ modulators specifications

Parameter	M3302A-C22			Units	Comments
	Min	Typ	Max		
General specifications					
IQ modulators	2				1 per output channel
Carrier signal source	FGs				refer FG specifications table in this document
Modulating signal source	AWGs				refer AWG specifications table in this document
External I/O trigger/marker					
Amplitude deviation	-1.5		1.5	V _p	
Phase deviation	-180		180	Deg	
I modulating signal resolution	16			Bits	AWG waveform
I modulating signal BW	0	250		MHz	AWG Nyquist limit
Q modulating signal resolution	16			Bits	AWG waveform
Q modulating signal BW	0	250		MHz	AWG Nyquist limit

Clock system specifications

Parameter	M3302A-C22			Units	Comments
	Min	Typ	Max		
General specifications					
Clock frequency ¹	> 100		500	MHz	

1. (-CLV) option: 100 to 500 MSa/s; (-CLF) option: fixed 500 MSa/s.

AC performance

Parameter	M3302A-C22			Units	Comments
	Min	Typ	Max		
General characteristics					
Analog output jitter		< 2		ps	RMS (cycle-to-cycle)
AWG trigger to output jitter		< 2		ps	RMS (cycle-to-cycle) for any trigger referenced to the chassis clock; independent of input trigger jitter if input jitter < 4nS peak-to-peak
Trigger resolution		10		ns	
Channel-to-channel skew		< 20		ps	Between ch 0 and ch 1, and ch 2 and ch 3
		< 50		ps	Between any channel
		< 150		ps	Between modules, chassis dependant ²
Clock output jitter		< 2		ps	RMS (cycle-to-cycle)
Clock accuracy and stability		100		ppm	PXle, PCIe versions; chassis dependant ¹
AC characteristics					
Spurious-free dynamic range (SFDR)					
					$P_{out} = 4 \text{ dBm}$, measured from DC to max frequency
$f_{out} = 10 \text{ MHz}$		68		dBc	
$f_{out} = 80 \text{ MHz}$		64		dBc	
$f_{out} = 120 \text{ MHz}$		57		dBc	
$f_{out} = 160 \text{ MHz}$		54		dBc	
Crosstalk (adjacent channels)					
$f_{out} = 10 \text{ MHz}$		< -105		dB	
$f_{out} = 80 \text{ MHz}$		-75		dB	
$f_{out} = 120 \text{ MHz}$		-88		dB	
$f_{out} = 160 \text{ MHz}$		-73		dB	
Crosstalk (non-adjacent channels)					
$f_{out} = 10 \text{ MHz}$		< -105		dB	
$f_{out} = 80 \text{ MHz}$		-78		dB	
$f_{out} = 120 \text{ MHz}$		< -105		dB	
$f_{out} = 160 \text{ MHz}$		-92		dB	
Phase noise (SSB)					
offset = 1 KHz		< -127		dBc/Hz	
offset = 10 KHz		< -133		dBc/Hz	
offset = 100 KHz		< -138		dBc/Hz	
Average noise power density					
		< -145		dBm/Hz	

1. This value corresponds to a M9505A chassis. This value can be improved with an external chassis clock or a system timing module.

2. This value corresponds to a M9005A PXle chassis.

AC performance, typical

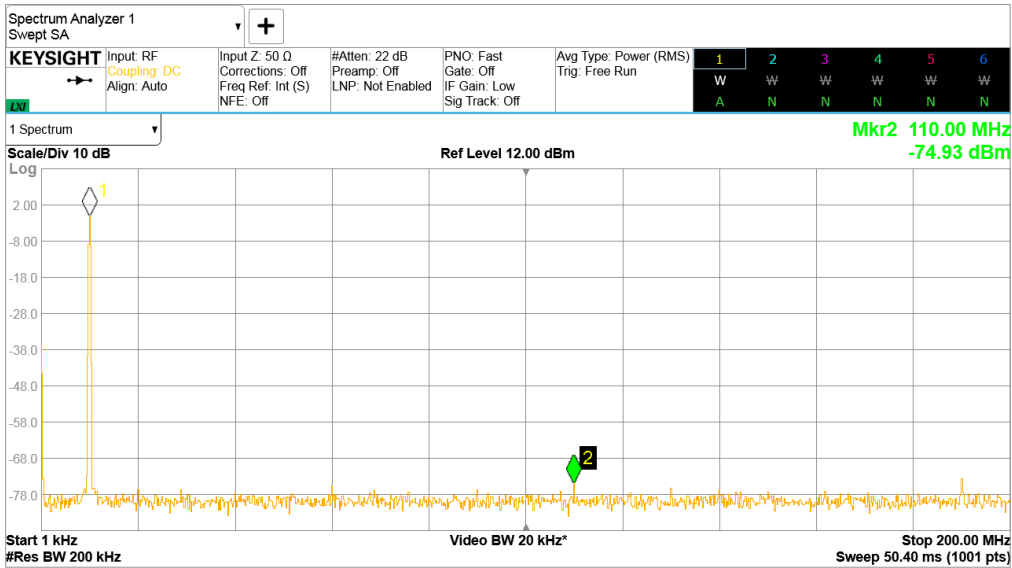

Figure 3. Single-tone spectrum at $f_{out} = 10$ MHz

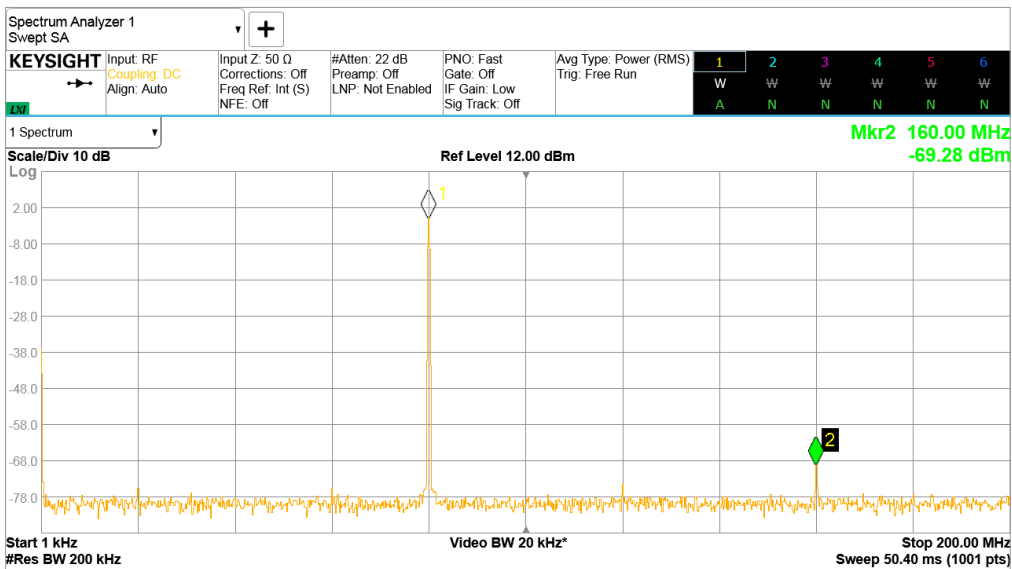

Figure 4. Single-tone spectrum at $f_{out} = 80$ MHz

AC performance, typical

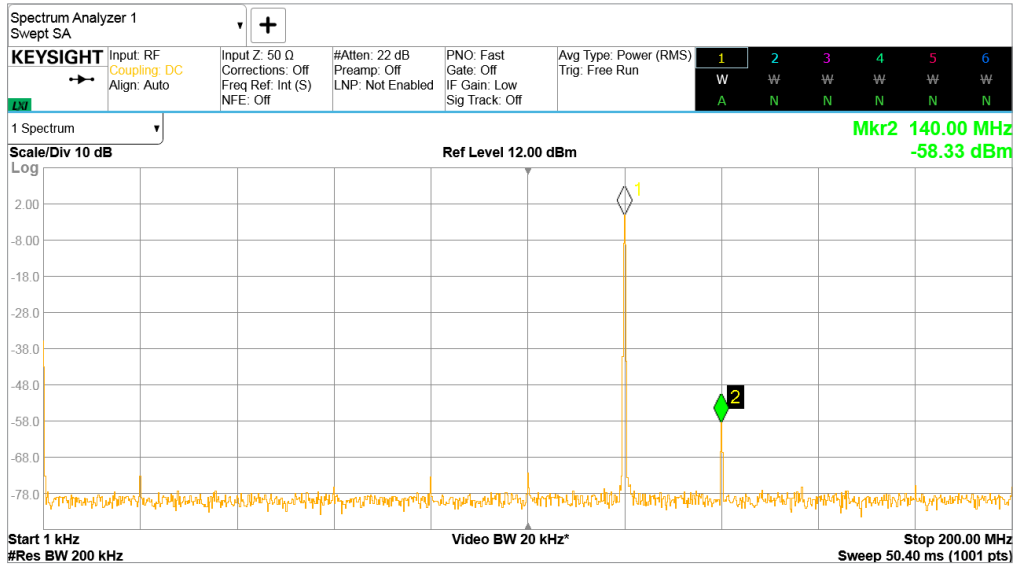

Figure 5. Single-tone spectrum at $f_{out} = 120$ MHz

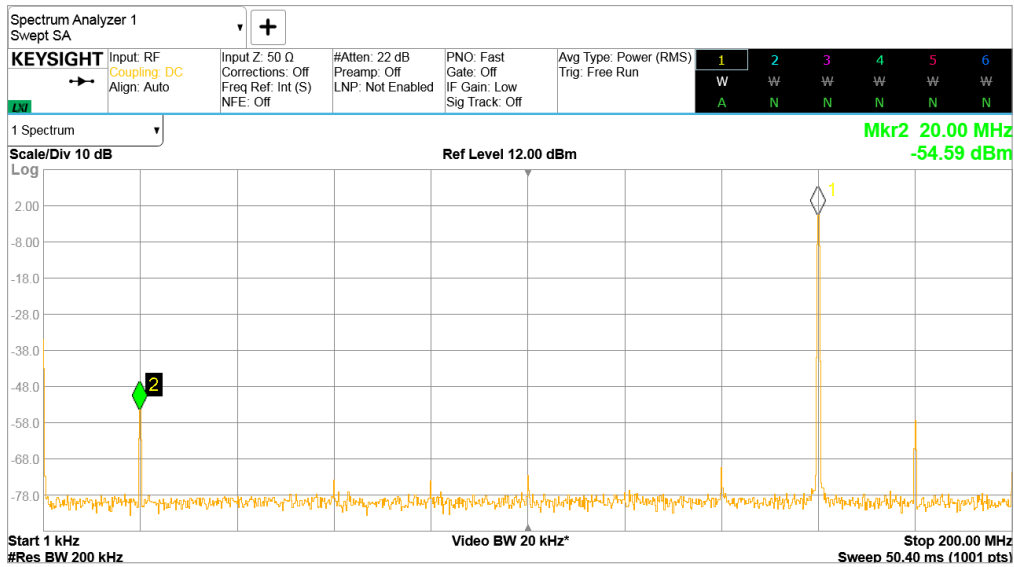

Figure 6. Single-tone spectrum at $f_{out} = 160$ MHz

Digitizer Technical Specifications and Characteristics

General characteristics

Parameter	M3302A-C22			Units	Comments
	Min	Typ	Max		
Inputs and outputs					
Channels		2		Out	
Reference clock ¹		1		Out	
Reference clock ²		1		In	
Triggers/markers ^{1,3}		1		In/out	Reconfigurable
Triggers/markers ^{2,3}		8		In/out	Reconfigurable
Input channels overview					
Sampling rate ⁴		500		MSa/s	
Voltage resolution		14		Bits	
Input frequency	0		200	MHz	
Real-time BW		200		MHz	
Time skew		< 50		ps	Between channels
Built-in functionalities					
Input conditioning blocks		2			1 per channel
Analog trigger processors		2			1 per channel
Data acquisition blocks		2			1 per channel
Onboard memory					
RAM memory	16		2048	MBytes	

1. At front panel.
2. At backplane.
3. Markers available from firmware version v3.0 or later.
4. (-CLV) option: 100 to 500 MSa/s; (-CLF) option: fixed 500 MSa/s.

I/O specifications

Analog input characteristics	
Number of channels	C22
Sampling rate	500 MSa/s option -CLF Variable rate option -CLV
Configurable inputs: impedance	50 Ω or 1 M Ω (HiZ)
Configurable inputs: Coupling	AC or DC
Input voltage range (50 Ω)	125 mVpp to 8 Vpp (7 scales: 0.125, 0.25, 0.5, 1, 2, 4, 8 Vpp)
Input voltage range (HiZ)	200 mVpp to 16 Vpp (7 scales: 0.2, 0.4, 0.8, 2, 4, 8, 16 Vpp)
Bandwidth limit filters	200 MHz
Effective number of bits (ENOB) ¹	10.6 bits at 95 MHz (typical)
Noise floor ¹	-146 dBm/Hz
SINAD ¹	66 dB at 95 MHz (typical)
Spurious free dynamic range (SFDR) + Total Harmonic Distorsion ¹	71 dBc at 95 MHz (typical)

1. Measured at -1 DBFS input signal with 1 Vpp 50 Ω .

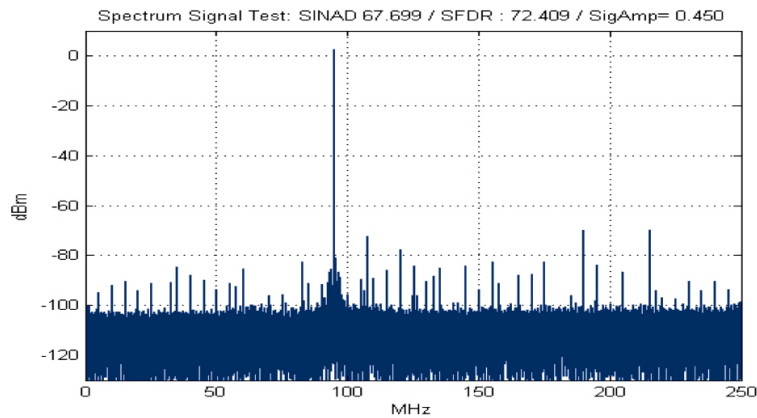

M3302A-C22					
Parameter	Min	Typ	Max	Units	Comments
Reference clock output					
Frequency		10 to 12.5 ²		MHz	Generated from the internal clock. User selectable
Voltage		800		mVpp	On a 50 Ω load
Power		2		dBm	On a 50 Ω load
Source impedance		50		Ω	AC coupled
External I/O trigger/marker					
V _{IH}	2		5	V	
V _{IL}	0		0.8	V	
V _{OH}	2.4		3.3	V	On a high Z load
V _{OL}	0		0.25	V	On a high Z load
Input impedance		10		K Ω	
Source impedance		TTL		-	
Speed		100		MHz	

2. CLF option is set to 10 MHz while with CLV option varies from 12.5 MHz to 10 MHz.

Data acquisition blocks (DAQs) specifications

Parameter	M3302A-C22			Units	Comments
	Min	Typ	Max		
General specifications					
DAQs	2				1 per channel
Aggregated speed	1000			MSa/s	For all onboard DAQs combined
Acquisition burst multiple	5			Samples	Burst length must be a multiple of this value
Acquisition RAM capacity	15	957M		Samples	Maximum depends on onboard RAM
Acquisition RAM capacity effic.	93.5			%	Effic. = waveform size/waveform size in RAM
Trigger	Selec.				Hardware trigger (analog channels, input trigger, backplane triggers), Software trigger
DAQ specifications					
Speed	500			MSa/s	Per DAQ
Resolution	14			Bits	

Clock system specifications

Parameter	M3302A-C22		Units	Comments
	Min	Max		
General specifications				
Clock frequency (-CLF)	500	500	MHz	Fixed clock
Clock frequency (-CLV)	100	500	MHz	Variable clock

System Specifications

Environmental specifications (PXI Express)

Parameter	M3302A-C22			Units	Comments
	Min	Typ	Max		
System bus					
Slots		2		Slots	PXI Express (CompactPCI Express compatible)
PCI Express type	Gen 1		Gen 2	-	Automatic gen negotiation, chassis dependent
PCI Express link	1		4	Lanes	Automatic lane negotiation, chassis dependent
Power dissipation					
3.3 V PXIe power supply		3		A	~ 10 W
12 V PXIe power supply		3.5		A	~ 40 W

Environmental ¹		
Temperature range	Operating	0 to +55°C (10,000 feet)
	Non-operating	-40 to +70 °C (up to 15,000 feet)
Max operative altitude		4000 m (10,000 feet)
Operating Humidity range (%RH)		10 to 95% at 40 °C
Non-operating Humidity range (%RH)		5 to 95%
Calibration interval		1 year
EMC		Complies with European EMC Directive - IEC/EN 61326-1 - CISPR Pub 11 Group 1, class A This ISM device is in compliance with Canadian ICES-001 Cet appareil ISM est conforme à la norme NMB-001 du Canada. This ISM device is in compliance with Australian and New Zealand RCM This ISM device is in compliance with South Korea EMC KCC

1. Samples of this product have been type tested in accordance with the Keysight Environmental Test Manual and verified to be robust against the environmental stresses of Storage, Transportation and End-use; those stresses include but are not limited to temperature, humidity, shock, vibration, altitude and power line conditions. Test Methods are aligned with IEC 60068-2 and levels are similar to MIL-PRF-28800F Class 3.

Ordering Information ¹

Product	Description
M3302A	Arbitrary waveform generator: 500 MSa/s, 16 Bits + digitizer: 500 MSa/s, 14 Bits
Options	Description
M3302A-C22	Two channels AWG + Two channels DIG ²
M3302A-CLV / -CLF	Variable sampling clock ² / fixed sampling clock, low jitter
M3302A-DM1	Dual modulation capability for the AWG (amplitude and angle simultaneously)
M3302A-M20	Memory 2 GB, 1 GSamples ²
HW programming options	Description
M3302A-HVI	Enabled HVI programming, requires an HVI design environment license (M3601A)
M3302A-FP1	Enabled FPGA programming, requires or -K41 option and an FPGA design environment license (M3602A)
M3302A-K41	FPGA, Xilinx 7K410T, required for -FP1 option only (needs memory option -M20)

Related software	Description
M3601A	HVI design environment
M3602A	FPGA design environment

1. All options must be selected at time of purchase and are not upgradable.
2. These options represent the standard configuration.

www.keysight.com/find/SignalStudio
www.keysight.com/find/m3302a

Learn more at: www.keysight.com

For more information on Keysight Technologies' products, applications or services, please contact your local Keysight office. The complete list is available at:
www.keysight.com/find/contactus

