

DT4252
DT4253
DT4254
DT4255
DT4256

HIOKI

Instruction Manual

DIGITAL MULTIMETER



EN

Feb. 2021 Revised edition 4
DT4251A981-04 21-02H



* 6 0 0 3 8 0 3 2 4 *

To customers using Model DT4254

WARNING

Your instrument can be used to measure voltages in excess of 1000 V DC if and only if both of the following conditions are satisfied:

1. The circuit under measurement is isolated from the commercial power grid.
2. The circuit under measurement is isolated from ground.



e.g.: when measuring the no-load voltage of an ungrounded PV panel

Do not use the instrument with circuits whose terminal-to-ground voltage exceeds 1000 V. Doing so may result in electric shock.

Contents

Introduction.....	1
Verifying Package Contents	1
Options (sold separately)	2
Safety Notes.....	5
Usage Notes.....	10

1 Overview 15

1.1 Overview and Features.....	15
1.2 Parts Names and Functions.....	16
1.3 Display	22
1.4 Alarm Display and Battery Indicator	23

2 Preparation for Measurements 25

2.1 Measurement Workflow	25
2.2 Inserting/Replacing Batteries	26
2.3 Using Test Leads.....	29
2.4 Installation in Measurement Location.....	32
Using the instrument with the stand.....	32
Attaching the magnetic strap	32
2.5 Using the Carrying Case	34

3 Performing Measurements 37

3.1 Inspection Before Use	37
3.2 Measuring Voltage.....	43
Measuring AC voltage.....	43
Measuring DC voltage	44
Measurement using the AC and DC automatic judgment (DT4253, DT4254, DT4255, DT4256).....	45
3.3 Measuring Frequencies	46

3.4	Checking Continuity (DT4252, DT4253, DT4255, DT4256)	47
3.5	Measuring Diode (DT4252, DT4253, DT4255, DT4256)	48
3.6	Measuring Resistance (DT4252, DT4253, DT4255, DT4256)	49
3.7	Measuring Temperatures (DT4253)	50
3.8	Measuring Electrostatic Capacities (DT4252, DT4253, DT4255, DT4256)	52
3.9	Measuring Current (DT4252, DT4253, DT4256)	53
	Measuring DC/AC Current.....	53
3.10	Measuring AC Current Using Clamp-on Probe (DT4253, DT4255, DT4256)	56
3.11	Checking the Electric Charge (DT4254, DT4255, DT4256)	58

4 Using Instrument Conveniently 59

4.1	Selecting the Measurement Range	59
	Measuring with the auto range	59
	Measuring with the manual range.....	59
4.2	Retaining the Measured Value	60
	Retaining the measured value manually (HOLD)	60
	Automatically retaining the measured value when the value stabilizes (AUTO HOLD).....	61
4.3	Reducing the Effect of the Noise (FILTER) .	64
4.4	Checking the Maximum/Minimum/Average 66	
4.5	Checking the Relative Value/Performing Zero Adjustment	67
	Checking the relative value (REL)	67
	Performing zero adjustment.....	69

4.6	Turning On the Backlight.....	70
4.7	Using the Auto Power Save (APS).....	70
4.8	Using Plus/Minus Judgment Function for Measurement Value (DT4254, DT4255, DT4256).....	71
4.9	Communicating with PC.....	72
4.10	Power-on Option Table	74
	Changing the temperature display unit	77

5 Specifications 79

5.1	General Specifications	79
5.2	Electrical Characteristics	81
5.3	Accuracy Table	83

6 Maintenance and Service 95

6.1	Repair, Inspection, and Cleaning.....	95
6.2	Troubleshooting	96
6.3	Error Display.....	99
6.4	Replacing Fuses.....	100

Appendix Appx.1

Appx. 1	RMS and Average	Appx.1
---------	-----------------------	--------

Introduction

Thank you for purchasing the HIOKI DT4252, DT4253, DT4254, DT4255, DT4256 Digital Multimeter. To obtain maximum performance from the product, please read this manual first, and keep it handy for future reference.

Verifying Package Contents

When you receive the instrument, inspect it carefully to ensure that no damage occurred during shipping.

In particular, check the accessories, panel switches, and connectors. If damage is evident, or if it fails to operate according to the specifications, contact your authorized Hioki distributor or reseller. Check the package contents as follows.

- Instrument** (The holster has been attached.) **L9207-10 Test Lead** (p. 29)

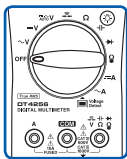
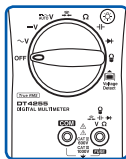
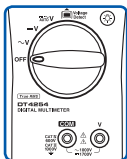
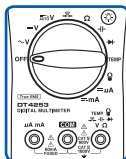

- LR03 Alkaline battery × 4**



- Instruction Manual**



(English)

Instruction manuals may also be available in other languages. Please visit our website at <http://www.hioki.com>.

Options (sold separately)

The following options are available for the instrument. Contact your authorized Hioki distributor or reseller when ordering. The options are subject to change. Visit our website for updated information.

Connecting cables

*1: CAT IV 600 V/CAT III 1000 V/CAT II 1000 V, 10 A

*2: CAT IV 600 V/CAT III 1000 V, 10 A

*3: 30 V AC/60 V DC, 3 A

*4: CAT III 300 V/CAT II 600 V, 3 A

*5: CAT II 1000 V, 1 A

*6: CAT III 600 V, 5 A

*7: CAT III 1000 V, 2 A

*8: CAT III 600 V/CAT II 600 V, 10 A

*9: CAT III 600 V, 10 A

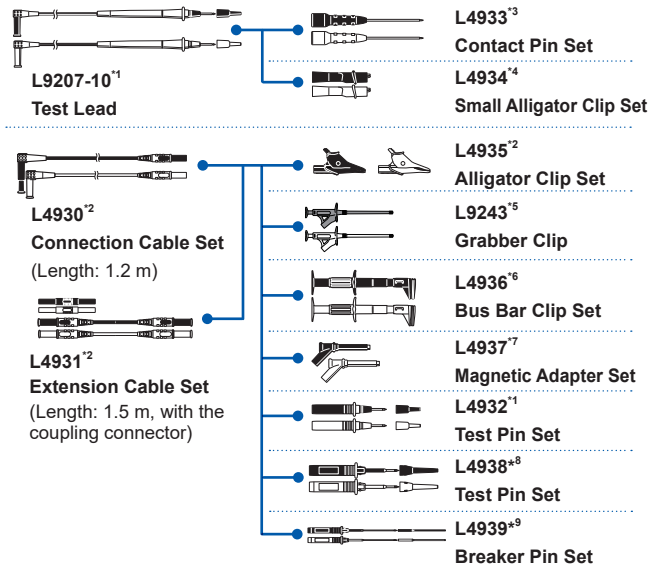

For the clamp current measurement (Compatible only with the DT4253, DT4255, and DT4256)



9010-50, 9018-50, 9132-50⁴

Clamp-on Probe

9704

Conversion Adapter

Clamp-on probe	Rated current	Diameter of the measurable conductor
9010-50, 9018-50	500 Arms	φ46 mm or less
9132-50	1000 Arms	φ55 mm or less, 80×20 mm bus-bar

Temperature measurement (Only the DT4253)

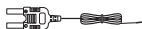

DT4910 Thermocouples (K) (p. 50)

- Temperature measuring junction: Exposed type (welding)
- Sensor length: Approx. 800 mm
- Operating temperature: -40°C to 260°C (temperature measuring part), -15°C to 55°C (connector)
- Allowable tolerance: ±2.5°C

Carrying Case

The instrument, test leads, instruction manual, and others can be stored in the case.



C0201 Carrying Case
(p. 34)



C0202 Carrying Case



3853 Carrying Case

Options (sold separately)

Z5004 Magnetic Strap (p. 32)



Attach this strap to the instrument and secure it on the wall surface such as a metal plate for use.

DT4900-01 Communication Package (USB) (p. 72)



A communication adapter, USB cable, PC software, and communication specifications are included. The instrument data can be stored on the PC.



Safety Notes

This instrument is designed to conform to IEC 61010 Safety Standards, and has been thoroughly tested for safety prior to shipment. However, using the instrument in a way not described in this manual may negate the provided safety features.

Before using the instrument, be certain to carefully read the following safety notes.

DANGER



Mishandling during use could result in injury or death, as well as damage to the instrument. Be certain that you understand the instructions and precautions in the manual before use.

WARNING



With regard to the electricity supply, there are risks of electric shock, heat generation, fire, and arc discharge due to short circuits. If persons unfamiliar with electricity measuring instruments are to use the instrument, another person familiar with such instruments must supervise operations.

Protective gear







WARNING











To avoid electric shock when measuring live lines, wear appropriate protective gear, such as insulated rubber gloves, boots and a safety helmet.

Notation



In this manual, the risk seriousness and the hazard levels are classified as follows.

 DANGER	Indicates an imminently hazardous situation that will result in death or serious injury to the operator.
 WARNING	Indicates a potentially hazardous situation that may result in death or serious injury to the operator.
 CAUTION	Indicates a potentially hazardous situation that may result in minor or moderate injury to the operator or damage to the instrument or malfunction.
IMPORTANT	Indicates information related to the operation of the instrument or maintenance tasks with which the operators must be fully familiar.
	Indicates a high voltage hazard. If a particular safety check is not performed or the instrument is mishandled, this may give rise to a hazardous situation; the operator may receive an electric shock, may get burnt or may even be fatally injured.
	Indicates a strong magnetic-field hazard. The effects of the magnetic force can cause abnormal operation of heart pacemakers and/or medical electronics.
	Indicates prohibited actions.
	Indicates the action which must be performed.
*	Additional information is presented below.

Symbols affixed to the instrument

	Indicates cautions and hazards. When the symbol is printed on the instrument, refer to a corresponding topic in the Instruction Manual.
	Indicates that dangerous voltage may be present at this terminal.
	Indicates a double-insulated device.
	Indicates a fuse.
	Indicates a grounding terminal.
	Indicates DC (Direct Current).
	Indicates AC (Alternating Current).
	Indicates DC (Direct Current) or AC (Alternating Current).

Symbols for various standards

	Indicates the Waste Electrical and Electronic Equipment Directive (WEEE Directive) in EU member states.
	Indicates that the instrument conforms to regulations set out by the EC Directive.

Screen display

This instrument uses the following screen displays.



A different display is used in the case below.



Appears when a broken Thermocouple (K) is detected. (p. 50)

Accuracy

We define measurement tolerances in terms of rdg. (reading) and dgt. (digit) values, with the following meanings:

rdg.	(Reading or displayed value) The value currently being measured and indicated on the measuring instrument.
dgt.	(Resolution) The smallest displayable unit on a digital measuring instrument, i.e., the input value that causes the digital display to show a "1" as the least significant digit.

Measurement categories

To ensure safe operation of measuring instruments, IEC 61010 establishes safety standards for various electrical environments, categorized as CAT II to CAT IV, and called measurement categories.

DANGER



- **Using a measuring instrument in an environment designated with a higher-numbered category than that for which the instrument is rated could result in a severe accident, and must be carefully avoided.**
- **Using a measuring instrument without categories in an environment designated with the CAT II to CAT IV category could result in a severe accident, and must be carefully avoided.**

This instrument conforms to the safety requirements for CAT III 1000 V, CAT IV 600 V measuring instruments.

- CAT II: When directly measuring the electrical outlet receptacles of the primary electrical circuits in equipment connected to an AC electrical outlet by a power cord (portable tools, household appliances, etc.)
- CAT III: When measuring the primary electrical circuits of heavy equipment (fixed installations) connected directly to the distribution panel, and feeders from the distribution panel to outlets
- CAT IV: When measuring the circuit from the service drop to the service entrance, and to the power meter and primary overcurrent protection device (distribution panel)

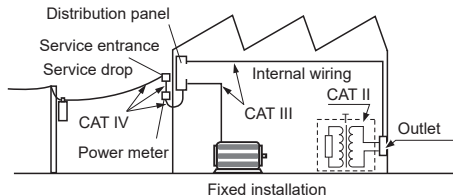

See: "2.3 Using Test Leads" (p. 29)

Usage Notes

Follow these precautions to ensure safe operation and to obtain the full benefits of the various functions.

DANGER

If the test lead or the instrument is damaged, there is a risk of electric shock. Before using the instrument, perform the following inspection.



- Before using the instrument, check that the coating of the test leads are neither ripped nor torn and that no metal parts are exposed. Using the instrument under such conditions could result in electrocution. Replace the test leads with those specified by our company.
- Before using the instrument for the first time, verify that it operates normally to ensure that no damage occurred during storage or shipping. If you find any damage, contact your authorized Hioki distributor or reseller.

Installation

Installing the instrument in inappropriate locations may cause a malfunction of instrument or may give rise to an accident. Avoid the following locations.

For details on the operating temperature and humidity, see the specifications. (p. 79)

CAUTION



- Exposed to direct sunlight or high temperature
- Exposed to corrosive or combustible gases
- Exposed to water, oil, chemicals, or solvents
- Exposed to high humidity or condensation
- Exposed to a strong electromagnetic field or electrostatic charge
- Exposed to high quantities of dust particles
- Near induction heating systems (such as high-frequency induction heating systems and IH cooking equipment)
- Susceptible to vibration

Handling the cables

WARNING

To prevent electric shock, when measuring the voltage of a power line use a test lead that satisfies the following criteria:



- Conforms to safety standards IEC61010 or EN61010
- Of measurement category III or IV
- Its rated voltage is higher than the voltage to be measured

All of the optional test leads for this instrument conform to the safety standard EN61010. Use a test lead in accordance with its defined measurement category and rated voltage.

CAUTION



- Avoid stepping on or pinching the cable, which could damage the cable insulation.
- To avoid damaging the cables, do not bend or pull the leads and the probe bases.



The ends of the test leads are sharp. Be careful to avoid injury.

For the test leads supplied with the instrument or the options to be connected to the instrument, see the following information.

Accessories and options	Reference
Test lead	"2.3 Using Test Leads" (p. 29)
Thermocouples (K)	"3.7 Measuring Temperatures (DT4253)" (p. 50)
Clamp-on probe	See the Instruction Manual which accompanies the optional clamp.
USB cable	"4.9 Communicating with PC" (p. 72)
Magnetic strap	"2.4 Installation in Measurement Location" (p. 32)

Precautions during measurement

WARNING



If the instrument is used in locations where the rating indicated on the instrument or probes is exceeded, the instrument may be damaged resulting in personal injury. Do not use the instrument in such locations. See “Measurement categories” (p. 9).

- With regard to the 10 A range, the maximum input current is 10 A DC/10 Arms AC. Supplying a current in excess of the maximum input may damage the instrument and result in personal injury. Do not supply current in excess of the specified limit. (Only the DT4252 and DT4256)

Observe the following to avoid electric shock and/or short circuits.



- Hazardous voltage may be generated in a free measurement terminal. Do not touch the free terminal.
- Use only test leads and optional equipment specified by our company.
- Do not allow the metal part of the test lead to touch any exposed metal, or to short between 2 lines. Never touch the metal end.
- When connecting the clip-type test lead to the active terminal, do not allow the lead to touch any exposed metal, or to short between 2 lines.
- When the clamp-on probe is opened, do not allow the metal part of the clamp to touch any exposed metal, or to short between 2 lines, and do not use over bare conductors. (For the clamp current measurement, only the DT4253, DT4255, and DT4256)

CAUTION



- Do not input voltage or supply current exceeding the specified measurement range. Doing so may damage the instrument.
- During the continuity check, diode test, or measurement of resistance or electrostatic capacity, measurement signals are generated in the terminals of the instrument. Depending on the target for measurement, the measurement signal may cause damage. See “Measurement current” and “Open circuit voltage” in the “5.3 Accuracy Table” (p.83) in advance, that there are no adverse effects of the measurement current and the open circuit voltage.

Precautions during shipment

Observe the following during shipment. Hioki cannot be responsible for damage that occurs during shipment.

CAUTION



- During shipment of the instrument, handle it carefully so that it is not damaged due to a vibration or shock.
- To avoid damage to the instrument, remove the accessories and optional equipment from the instrument before shipment.

If the instrument is not to be used for an extended period of time

IMPORTANT

To avoid corrosion and/or damage to the instrument due to battery leakage, remove the batteries from the instrument if it is to be kept in storage for an extended period.

1

Overview

1.1 Overview and Features

This measuring instrument is a multi-function digital multimeter that ensures both safety and durability.

Main features and functions

- Speedy display of the RMS measured value
 - Environmental performance (can be used anywhere)
 - High noise-proof performance
 - Filter function that controls the influence of noise
 - Display hold (HOLD)
 - Solid body which can be used for an extended period of time (drop-proof)
 - Maximum/minimum/average display
 - Speedy measurement via a fast response (0 V → 100 V response approx. 0.6 seconds*)
- * Until the value falls within the accuracy specification range.

If there is an excessive input, a hazard is indicated by the red LED.

Problem finding a suitable installation location?

The strap with magnet allows the instrument to be hung conveniently.



Data transmission to PC, control

The optional DT4900-01 Communication Package is required.



For various purposes

The measurement test leads and end pins can be selected.

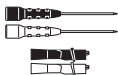

Large, easily-viewable display

Backlighting to allow users to read the measurement values in dark environments

Dual display

Two types of measured values are displayed at the same time.



1.2 Parts Names and Functions

Front

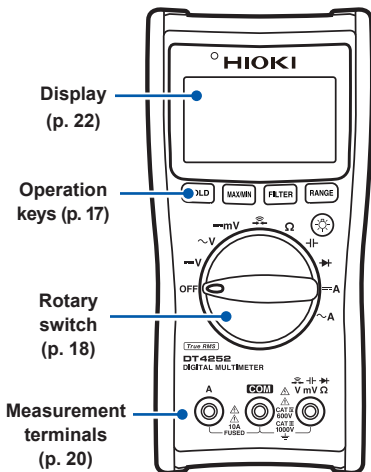

Some indications are different among the models.

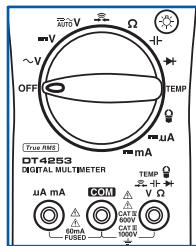

DT4252

DT4253

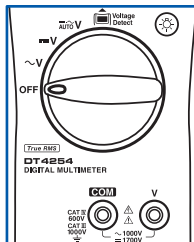

DT4254

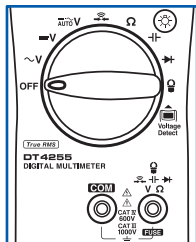



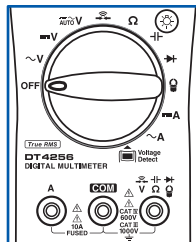



DT4255

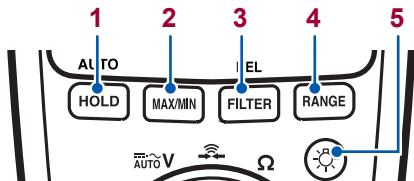













DT4256



Operation keys



	Normal	Pressed down for at least 1 second	Power-on option (p. 74)	
1	 HOLD	Manually sets/cancels the hold function for the displayed value.	Sets/cancels the auto hold function for the displayed value.	Cancels the auto power save function (APS).
	HOLD lights up/goes off.	HOLD blinks/lights up.	APS goes off.	
2	 MAX/MIN	Specifies/switches the display of the maximum, minimum, and average values.	Cancels the display of the maximum, minimum, and average values.	Sets/cancels the plus/minus judgment function.
	MAX / MIN / AVG lights up/goes off.			
3	 FILTER	Switches/cancels the low pass filter and passband settings.	Sets/cancels the display of the relative value (REL, ΔT).	Turns off the buzzer.
	FILTER lights up/goes off.	REL (ΔT) lights up/goes off.		
4	 RANGE	Sets the manual range/switches the range, and sets the clamp current range, sets the sensitivity of the electric charge detection.	Cancels the manual range.	All LCD's light up and the software version and the adjustment source are displayed.
	RANGE: AUTO / RANGE: MANUAL			
5		Turns on/off the backlight.	-	Turns off the automatic backlight deactivation.

Rotary switches and measurement descriptions

Function	DT4252	DT4253	DT4254	DT4255	DT4256
OFF					
 AC voltage and frequency measurement	√	√	√	√	√
 DC voltage measurement	√*1	√	√*5	√	√
 DC voltage measurement (High accuracy 600.0 mV range)	√	-	-	-	-
 DC/AC voltage measurement (Automatic judgment) Input impedance 900 kΩ±20%	-	√	√*4	√	√
 Continuity check	√	√	-	√	√
 Resistance measurement	√	√	-	√	√
 Electrostatic capacity	√	√	-	√	√
 Diode test	√	√	-	√	√
 AC measurement (Clamp sensor used)	-	√	-	√	√
 Electrical charge measurement	-	-	√	√	√
TEMP Temperature measurement	-	√	-	-	-
 DC current (μA) measurement	-	√	-	-	-
 DC current (mA) measurement	-	√	-	-	-

Function		DT4252	DT4253	DT4254	DT4255	DT4256
 A	DC current (A) measurement	√*2	-	-	-	√
 A	AC current (A) and frequency measurement	√*3	-	-	-	√

*1: No 600.0 mV range

*2: No 60.00 mA and 600.0 mA range

*3: No 600.0 mA range

*4: Input impedance 1800 kΩ±20%

*5: Maximum allowable measurement range: 1700 V

Measurement terminals

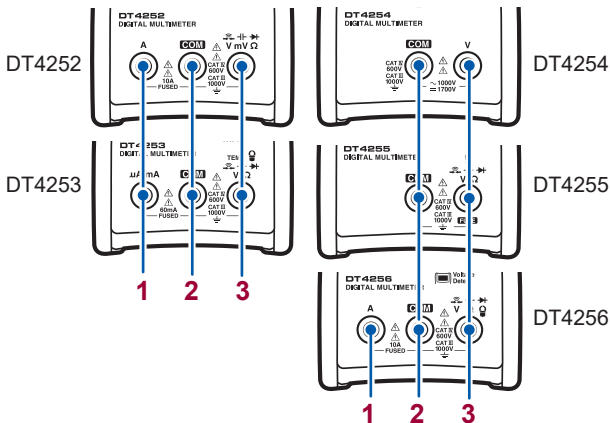

- 1** Current measurement terminal.
Hereafter referred to as “A terminal (μA terminal, mA terminal)”.
The red test lead is connected.

- 2** Commonly used for each measurement.
Hereafter referred to as “COM terminal”.
The black test lead is connected.

- 3** Used for voltage measurement, resistance measurement, continuity check, diode test, temperature measurement, electrostatic capacity measurement, or clamp current measurement.
Hereafter referred to as “V terminal”.
The red test lead is connected.

Be sure to carefully read the following precautions for the terminals with the  marking.

- “Precautions during shipment” (p. 13)
- “6.4 Replacing Fuses” (p. 100)

Rear

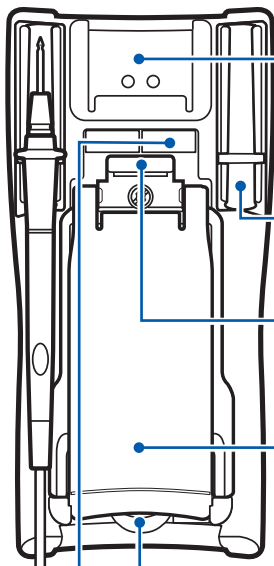
**Communication port**

When the communication adapter supplied with the optional DT4900-01 Communication Package is connected, the data can be transmitted to the PC. (p. 72)

Test lead holder

The test lead can be held.

Strap hole

The optional Z5004 Magnetic Strap can be attached. (p. 32)

Stand

The instrument can be set on the stand. (p. 32)

Battery cover

When replacing the batteries (p. 26) or fuse (p. 100), remove the cover.

⚠ See p. 26.

Serial number label

The 9-digit serial number indicates the year (first two digits) and the month of manufacture (next two digits).

Do not remove this sticker as the number is important.

1.3 Display

For error displays, see “6.3 Error Display” (p. 99).

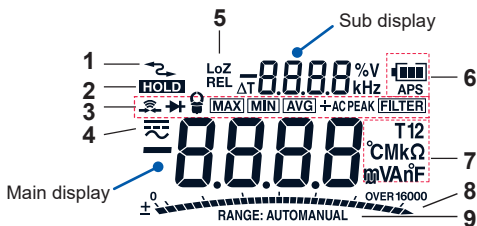

- | | | | | | |
|---|----------------------------------|---|--|---|--|
| 1 | | Communicating with the PC. (p. 72) | | | |
| 2 | HOLD | Retention of the measured value. (p. 60) | | 5 | ΔT
• Relative value display (during temperature measurement)
• Temperature difference from the standard. (p. 68) |
| | | Continuity check (p. 47) | | | Battery indicator (p. 23) |
| | | Diode (p. 48) | | 6 | APS The auto power save function is activated. (p. 70) |
| | | Clamp current measurement (p. 56) | | | Each unit |
| 3 | MAX MIN AVG | Maximum value (MAX), minimum value (MIN), average value (AVG) | | 7 | T12 (T1, T2) Lights up when the relative value of the temperature is displayed. |
| | FILTER | The filter function is activated. (p. 64) | | | |
| 4 | | AC, DC | | 8 | Indication (example): In the case of 30.00 V input in the 60.00 V range, the bar is displayed to the center of the scale. |
| | LoZ | AC, DC automatic judgment | | 9 | RANGE: AUTO MANUAL
Auto range, manual range (p. 59) |
| 5 | REL | Relative value display (measurement other than temperature) (p. 67) | | | |

1.4 Alarm Display and Battery Indicator

When the measured value exceeds the maximum input range in each range



Voltage/Current measurement

The measured value and **OVER** blink and the red LED lights up.



Measurement other than voltage and current

The measured value and **OVER** blink.

Corrective action:

When the input exceeds the maximum rating, immediately move the test leads away from the measurement object.

When the thermocouple is broken



(Temperature measurement) Thermocouple (K)

Corrective action:

Check that the thermocouple has been connected correctly to the measurement terminal. If the display does not change, Thermocouple (K) is broken. Replace with a new Thermocouple (K).

Battery warning indicator

	Fully charged.
	As the battery charge diminishes, black charge bars disappear, one by one, from the left of the battery indicator.
	The battery voltage is low. Replace the batteries as soon as possible.
	(Blinks) The battery is exhausted. Replace the batteries.

The charge is only a reference for the continuous operation time.

Power shutdown



When the charge is 0% (less than $4.0\text{ V} \pm 0.1\text{ V}$), "bAtt" appears in the display for 3 seconds and the power is shut down.

2

Preparation for Measurements

2.1 Measurement Workflow

Before using the instrument, be sure to read “Usage Notes” (p. 10).

Installation and connection

Insert the batteries. (p. 26)

As necessary, have other optional items available and ready.

Perform the startup check. (p. 37)

Measurement

Turn on the power and select the measurement function.

To ensure safe operation, make sure to select a measurement function and then connect the test leads to the measurement object.

Attach the test leads to the measurement terminals. (p. 29)
(As necessary, perform zero adjustment. (p. 69))

Connect the test leads to the measurement object.

(As necessary)

Hold the measured value. (p. 60)

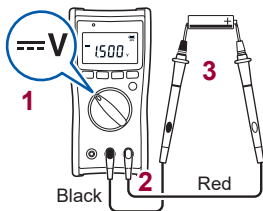

(The position of the rotary switch varies depending on the model.)

End of the measurement

Move the test leads away from the measurement object and then turn off the power.

2.2 Inserting/Replacing Batteries

Before using the instrument, insert four LR03 alkaline batteries. Before measurements, check that the battery level is sufficient. When the battery charge is low, replace the batteries.

Nickel-metal hydride batteries

Nickel-metal hydride batteries can be used. However, the discharge characteristic of these batteries is different from that of alkaline batteries. Be aware that the remaining battery power display does not function properly.

WARNING



To avoid electric shock, disconnect the test leads from the object to be measured before replacing the batteries.



To avoid the possibility of explosion, do not short circuit, charge, disassemble, or incinerate batteries.



- After battery replacement but before using the instrument, reattach and screw down the battery cover.
- To prevent instrument damage or electric shock, use only the screw for securing the battery cover in place that shipped with the instrument. If you have lost a screw or find that a screw is damaged, please contact your Hioki distributor for a replacement.

 **CAUTION**

Poor performance or damage from battery leakage could result. Observe the cautions listed below.



- Do not mix new and old batteries, or different types of batteries.
- Be careful to observe the battery polarity during installation.
- Do not use batteries after their recommended expiry date.
- Do not allow used batteries to remain in the instrument.



- To avoid corrosion from battery leakage and/or damage to the instrument, remove the batteries from the instrument if it is to be kept in storage for an extended period.

- The  indicator appears when the battery charge diminishes. Replace the batteries as soon as possible. The power may be turned off when the backlight lights up or a buzzer sounds.
- After use, be sure to turn off the instrument.
- Handle and dispose of batteries in accordance with local regulations.

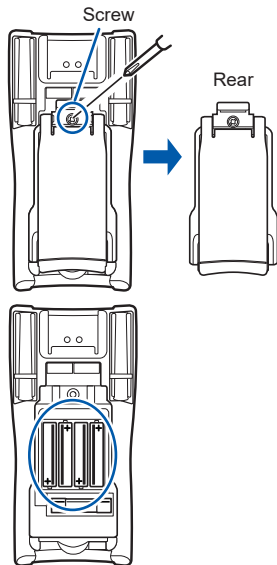
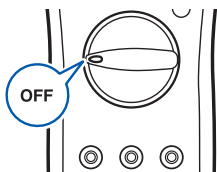

- 1** Have the following items available and ready.
 - Phillips screwdriver
 - LR03 Alkaline battery × 4
- 2** Remove the test leads from the instrument.
- 3** Set the rotary switch to OFF.
- 4** Using a Phillips screwdriver, remove the screw (1 location) from the battery cover on the rear of the instrument.
- 5** Remove the battery cover.
- 6** Remove all of the old batteries.
- 7** Insert 4 new batteries (LR03), being careful to the battery polarity.
- 8** Reattach the battery cover.
- 9** Secure the cover with the screw.

(Only the DT4252, DT4253, DT4255, and DT4256)
After the battery cover is removed, the fuse can be seen. When replacing the fuse, see “6.4 Replacing Fuses” (p. 100).

2.3 Using Test Leads

The L9207-10 Test Lead supplied with the instrument are used for measurements.

Depending on measurement locations, use our optional measurement cables. For details on the optional items, see “Options (sold separately)” (p. 2).

WARNING



- **To prevent a short circuit accident, be sure to use the test leads with the sleeves attached when performing measurements in the CAT III and CAT IV measurement categories. (See “Measurement categories” (p. 9))**
- **If the sleeves are inadvertently removed during measurement, stop the measurement.**

CAUTION



- To ensure safe operation, use only test leads specified by our company.
- When carrying out measurements with the sleeves in place, be careful to avoid damaging the sleeves. Do not use sleeves that are damaged.
- The tips of the metal pins are sharp and may cause injury. Do not touch the tips.

L9207-10 Test Lead

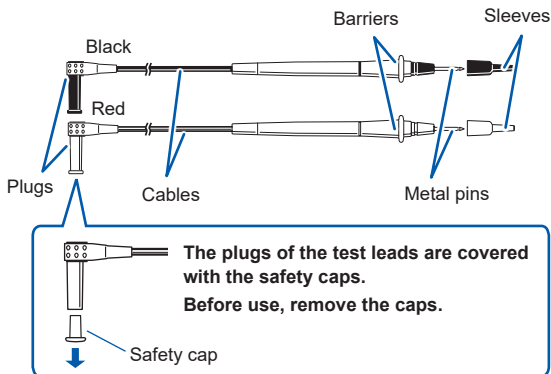

Metal pin	Connect to the object to be measured. 4 mm or less (sleeve attached) 19 mm or less (sleeve removed) Diameter ϕ approx. 2 mm
Sleeve	Attach to the metal pins to prevent short circuit accidents.
Barrier	Represents the safe handling distance from the metal pins.
	During measurement, do not touch the area between the barrier and the tip of the sleeve.
Plug	Connect to the measurement terminals on this instrument.
Cable	Double sheathed cables (Length: approx. 900 mm, Diameter: ϕ approx. 3.6 mm)

When the white portion inside the cable is exposed, replace with a new L9207-10 Test Lead.

Removing and attaching the sleeves

Removing the sleeves

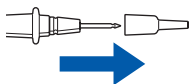

Gently hold the bottom of the sleeves and pull the sleeves off. Safely store the removed sleeves so as not to lose them.

Attaching the sleeves

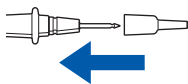

Insert the metal pins of the test leads into the holes of the sleeves, and firmly push them all the way in.

Connecting to the instrument

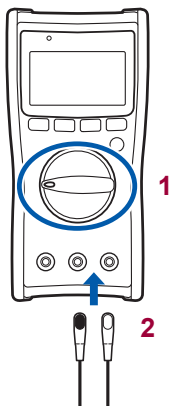

- 1 Turn the rotary switch to the desired measurement function.
- 2 Connect the test leads to the relevant measurement terminals.

- Besides the current measurement (excluding the clamp)

COM terminal Connect the black test lead.
V terminal Connect the red test lead.

- Current measurement

COM terminal Connect the black test lead.
 $\mu\text{A}/\text{mA}$ terminal Connect the red test lead.
 (DT4253)
A terminal
 (DT4252, DT4256)

2.4 Installation in Measurement Location

Using the instrument with the stand

Position the instrument with the stand at the rear.

CAUTION



- Do not position the instrument on an unstable table or inclined surface.
- When the instrument is set on the stand, do not apply a strong force above. Doing so may damage the stand.

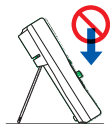

Attaching the magnetic strap

Attach the optional Z5004 Magnetic Strap to the instrument and attach the magnet to the wall surface (with metal plate affixed).

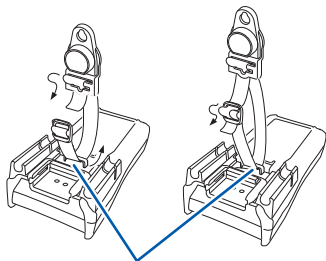

Strap holes

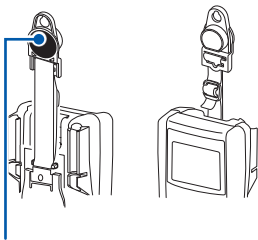

Magnet

Attach it to the wall surface (with metal plate affixed).

 **DANGER**

Those with medical electronics such as pacemakers should not use the Z5004 Magnetic Strap. Nor should such persons approach the Z5004. It is extremely dangerous. The electronics may not operate properly and the life of the operator may be put at great risk.

 **CAUTION**

- Do not use the Z5004 in locations where it may be exposed to rainwater, dust, or condensation. In those conditions, the Z5004 may be decomposed or deteriorated. The magnet adhesion may be diminished. In such case, the instrument may not be hung in place and may fall.
- Do not bring the Z5004 near magnetic media such as floppy disks, magnetic cards, pre-paid cards, or magnetized tickets. Doing so may corrupt and may render them unusable. Furthermore, if the Z5004 is brought near precision electronic equipment such as PCs, TV screens, or electronic wrist watches, they may fail.

2.5 Using the Carrying Case

C0201 Carrying Case

The instrument can be stored.

The test leads can be stored.

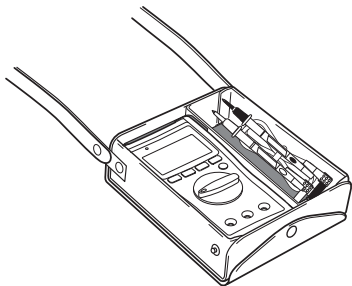
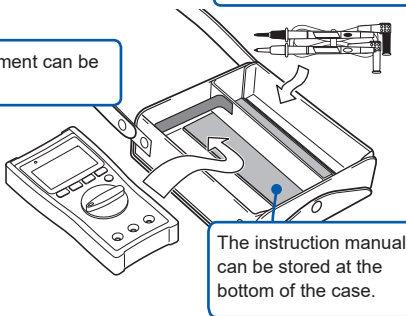

Removing the cover

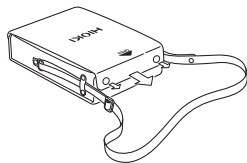

- 1** Unfasten the button on the side of the cover marked with OPEN.

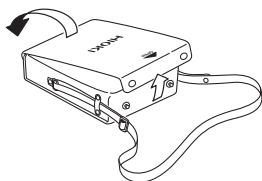

- 2** Flip the cover to the back.

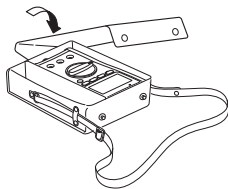

- 3** Fasten the button.

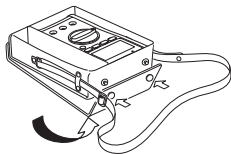

Using the instrument with a strap around the neck

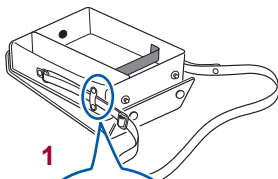
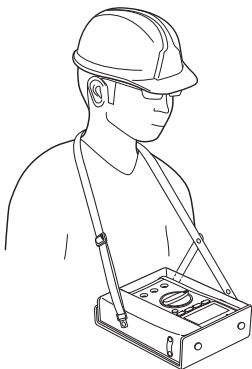

1



Unfasten
the button.

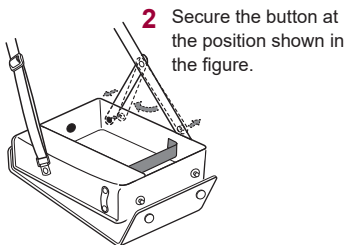

2 Secure the button at
the position shown in
the figure.

3

Performing Measurements

3.1 Inspection Before Use

Before using the instrument the first time, verify that it operates normally to ensure that no damage occurred during storage or shipping. If you find any damage, contact your authorized Hioki distributor or reseller.

Appearance check of the instrument and test leads

Check item	Action
The instrument is neither damaged nor cracked. The internal circuits are not exposed.	Visually check the instrument. If it is damaged, there is a risk of electric shock. Do not use the instrument but send it for repair.
The terminals are not contaminated with debris.	Remove contamination with a cotton swab.
The coating of the test leads is neither broken nor frayed, or the white portion or metal part within the lead is exposed.	If the test lead is damaged, there is a risk of electric shock. Do not use the instrument but send it for repair.

Check when turning on the power

(Set the rotary switch to any position other than OFF.)

Check item	Action
The battery voltage is sufficient.	When the  indicator appears in the top right corner of the display, the battery voltage is low. Replace the batteries as soon as possible. The power may be turned off when the backlight lights up or a buzzer sounds.

Check item	Action
No indicators are missing.	Display all indicators and ensure that no indicators are missing. (p. 75) If any of the indicators are missing, send the instrument for repair.

Operation check

This section introduces some of the operation checks. Periodical calibration is necessary in order to ensure that this instrument operates according to its specifications.

1 Check that the test leads are not broken.

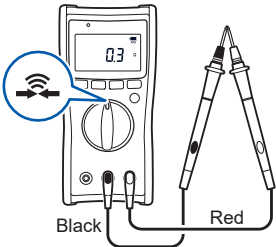
Check method	Action
<p>Regarding the continuity check, deliberately short circuit the test leads and then check the display.</p>  <p>Black Red</p> <p>For the DT4254: Check that there is nothing abnormal in operation check 2 (p.39).</p>	<p>Normal: A buzzer sounds and the value stabilizes at around $0\ \Omega$.</p> <p>Abnormal: A buzzer does not sound and a numeric value other than the above appears.</p> <p>Corrective action: The test leads may be broken. Replace with those specified by our company. If the same phenomena persist even after the test leads are replaced, a malfunction may occur. Halt inspection and then send the instrument for repair.</p> <p>For the DT4255, the fuse may be broken. Check that the fuse is not broken. (p.41)</p>

2 Measure samples (such as battery, commercial power supply, and resistor) of which values have already been known, and check that the appropriate values appear.

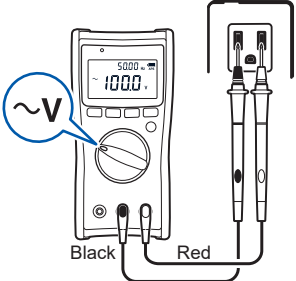
Check method	Action
<p>Example: Perform the AC voltage measurement to measure the commercial power supply, and then check the display.</p>  <p>(The position of the rotary switch varies depending on the model.)</p>	<p>Normal: An already-known value appears. (In this example, the commercial voltage level should appear.)</p> <p>Abnormal: The measured value does not appear. The malfunction may occur. Stop the inspection and do not use the instrument.</p>

3 Check that the fuse is not broken.

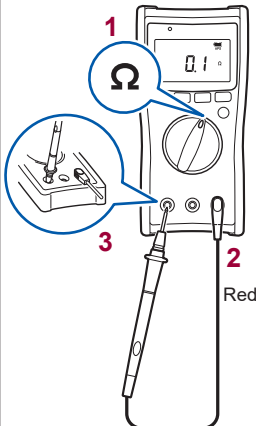
DT4252, DT4256 check method	Action				
<ol style="list-style-type: none"> Set the rotary switch to resistance measurement. Connect the tip of the red test lead to the A terminal and check the display. 	<p>Normal:</p> <table border="1" data-bbox="528 283 927 371"> <thead> <tr> <th>Fuse rating</th> <th>Resistance</th> </tr> </thead> <tbody> <tr> <td>11 A</td> <td>1 Ω or less</td> </tr> </tbody> </table> <p>Abnormal: If the value above is not obtained (the value higher than that is displayed), replace the fuse. (p.100)</p>	Fuse rating	Resistance	11 A	1 Ω or less
Fuse rating	Resistance				
11 A	1 Ω or less				

DT4253 check method	Action				
<ol style="list-style-type: none"> Remove the fuse from the instrument. (p. 100) Reattach the battery cover. In the resistance measurement, check the resistance of the fuse. (Resistance measurement (p. 49)) 	<p>Normal:</p> <table border="1" data-bbox="528 1099 927 1186"> <thead> <tr> <th>Fuse rating</th> <th>Resistance</th> </tr> </thead> <tbody> <tr> <td>250 mA</td> <td>2 to 7 Ω</td> </tr> </tbody> </table> <p>Abnormal: If the value above is not obtained (the value higher than that is displayed), replace the fuse. (p. 100)</p>	Fuse rating	Resistance	250 mA	2 to 7 Ω
Fuse rating	Resistance				
250 mA	2 to 7 Ω				

DT4255 check method	Action				
<p>If normal at “1 Check that the test leads are not broken.” (p.38), the check below is unnecessary.</p> <p>Abnormal:</p> <ol style="list-style-type: none"> 1. Remove the fuse from the instrument. (p. 100) 2. Check the resistance value of the fuse using other tester. 	<p>Normal:</p> <table border="1" data-bbox="526 234 919 321"> <thead> <tr> <th data-bbox="526 234 720 276">Fuse rating</th> <th data-bbox="723 234 919 276">Resistance</th> </tr> </thead> <tbody> <tr> <td data-bbox="526 281 720 321">630 mA</td> <td data-bbox="723 281 919 321">1 to 5 Ω</td> </tr> </tbody> </table> <p>Abnormal:</p> <p>If the value above is not obtained (the value higher than that is displayed), replace the fuse. (p. 100)</p>	Fuse rating	Resistance	630 mA	1 to 5 Ω
Fuse rating	Resistance				
630 mA	1 to 5 Ω				

4 Check that the electric charge detection function operates normally. (Only the DT4254, DT4255, and DT4256)

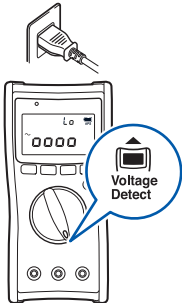
Check method	Action
<p>Position the detector on a known power supply, such as a power outlet.</p>  <p>(The position of the rotary switch varies depending on the model.)</p>	<p>Normal:</p> <p>A buzzer sounds and the red LED lights up (detecting mode).</p> <p>Abnormal:</p> <p>The display does not change. A buzzer does not sound or the red LED does not light up.</p> <p>Solution:</p> <p>A malfunction may have occurred. Stop the inspection and do not use the instrument.</p>

To check the electric charge properly, do not use the instrument with test leads wrapped around the instrument. The sensitivity of electric charge detection deteriorates.

Before measurements

WARNING

Observe the following to avoid short circuit accidents.



- Always verify the appropriate setting of the rotary switch before connecting the test leads.
- Move the test leads away from the measurement object before switching the rotary switch.
- Operate or connect the instrument by following the procedure of each measurement example (or procedure steps).

3.2 Measuring Voltage

AC/DC voltage measurement and measurement using the AC and DC automatic judgment (only the DT4253, DT4254, DT4255, and DT4256) can be performed. Furthermore, the maximum, minimum, and average values of the measured values can be checked. (p.66)

Before measurements

WARNING



If the instrument is used in locations where the rating indicated on the instrument or probes is exceeded, the instrument may be damaged resulting in personal injury. Do not use the instrument in such locations. See “Measurement categories” (p. 9).

The auto-ranging function of this instrument automatically selects the optimum measurement range. To change the range arbitrarily, use the manual range. (p. 59)

Measuring AC voltage

Measure the AC voltage. Measure the frequency simultaneously. The measured value is a true RMS. (p. Appx.1)

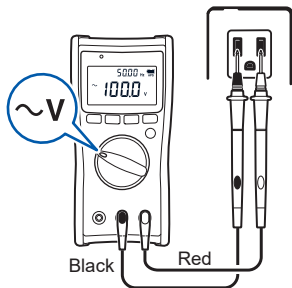

(The position of the rotary switch varies depending on the model.)

Measuring DC voltage

Measure the DC voltage.

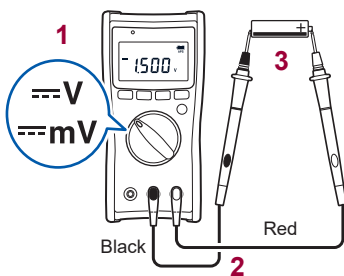

“4.8 Using Plus/Minus Judgment Function for Measurement Value (DT4254, DT4255, DT4256)” (p.71)

mV is only used for the DT4252.
(The position of the rotary switch varies depending on the model.)

Measurement using the AC and DC automatic judgment (DT4253, DT4254, DT4255, DT4256)

The AC and DC are automatically judged and the voltage is measured.
(The instrument does not measure both AC and DC at the same time.)

“4.8 Using Plus/Minus Judgment Function for Measurement Value (DT4254, DT4255, DT4256)” (p.71)

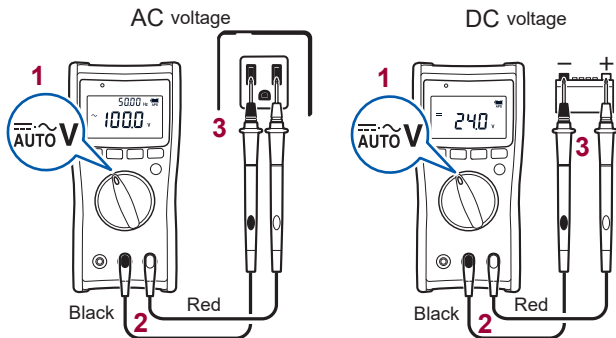

3.3 Measuring Frequencies

During voltage/current measurement of AC, the frequency can be checked in the sub display. The frequency display is auto-ranging. The AC voltage and current ranges can be changed by pressing the RANGE key.



- If signals out of the range of frequency measurement are measured, “-----” appears. Be aware of it.
- In a measurement environment with a large amount of noise, the frequency may be displayed even with no input. This does not indicate a malfunction of the instrument.
- The sensitivity of the frequency measurement is regulated by range. (Minimum sensitivity voltage, Minimum sensitivity current (p. 85))
When the value is less than the minimum sensitivity voltage (current), the indicated value may fluctuate. When the voltage (current) range is lowered, the value stabilizes. This does not apply to cases where the value fluctuates due to noise.
- During the measurement of low frequency voltage (current), if the auto range does not stabilize and the frequency cannot be measured, fix the voltage (current) range and measure again.

3.4 Checking Continuity (DT4252, DT4253, DT4255, DT4256)

The input short circuit is detected and informed via a buzzer and red LED.

⚠ WARNING



Before measuring, be sure to turn off the power to the measurement circuit. Otherwise, electric shock may occur or the instrument may be damaged.

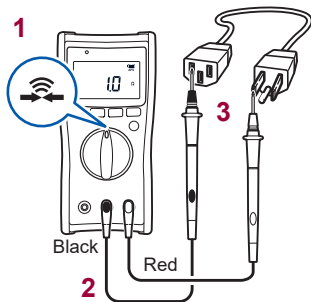

Detection	Threshold	Buzzer	Red LED
Short circuit detection	$25 \Omega \pm 10 \Omega$	Sounds (continuous buzzer sound)	Turns on
Open detection	$245 \Omega \pm 10 \Omega$	Does not sound	Turns off

A buzzer sounds before the red LED lights up. Since the buzzer and red LED settings have different thresholds, the thresholds' error margin may cause the red LED to stay off even if the buzzer sounds.

3.5 Measuring Diode (DT4252, DT4253, DT4255, DT4256)

The forward voltage of the diode is measured. If the forward voltage is within the range from 0.15 V to 1.5 V, it is indicated via a buzzer (intermittent buzzer sound) and red LED.

WARNING



Before measuring, be sure to turn off the power to the measurement circuit. Otherwise, electric shock may occur or the instrument may be damaged.

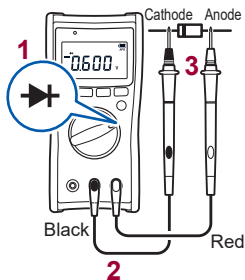

In the case of the opposite connection



The open terminal voltage is approx. 5.0 V or less.
To avoid damage to the measurement object, check the specifications of the measurement object before use.

3.6 Measuring Resistance (DT4252, DT4253, DT4255, DT4256)

Resistance is measured.

To measure the low resistance accurately, it is necessary to cancel the resistance of the test leads. Perform zero adjustment for the displayed value using the relative value display (relative function p.67) in advance.

WARNING



Before measuring, be sure to turn off the power to the measurement circuit. Otherwise, electric shock may occur or the instrument may be damaged.

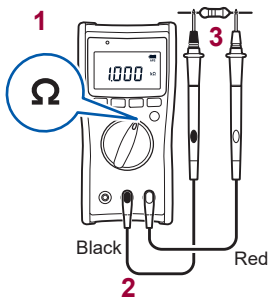

The auto-ranging may not stably operate depending on the object under measurement, such as a motor, a transformer, and a coil. In this case, choose an appropriate range manually. (p. 59) Besides, capacitive components parallel-connected with the object under measurement may result in inaccurate measured values.

The open terminal voltage is approx. 1.8 V or less. The measurement current (DC) varies depending on the range. To avoid damage to the measurement object, check the specifications before use.

3.7 Measuring Temperatures (DT4253)

Using our optional DT4910 Thermocouples (K), temperatures can be measured.

CAUTION



To avoid damage to the instrument, do not input any voltage or supply current to the thermocouple.

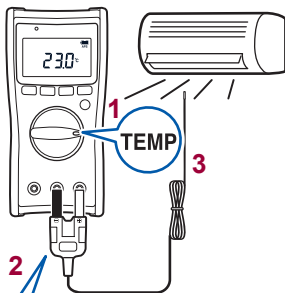

When a breaking state of the Thermocouples (K) is detected

OPEN

Checking the temperature change

It can be checked in the relative value display. (p. 68)

Changing the temperature units

Celsius and Fahrenheit can be switched. (p. 77)

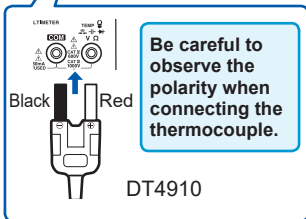

When measuring temperatures with the thermocouple applied to the surface of the measurement object

Clean the surface so that the thermocouple can make contact with the object securely.

If no numeric value is displayed after the thermocouple is attached ([OPEn] is displayed):

The instrument or thermocouple may be malfunctioning. Check this with the following procedure.

1 Short-circuit the V and COM terminals of the instrument using the test leads.

The ambient temperature is displayed.	To step 2
--	-----------

The ambient temperature is not displayed.	The instrument is malfunctioning. Send it for repair.
--	---

2 Connect the thermocouple in the correct direction.

[OPEn] remains displayed.	The thermocouple may be malfunctioning (blown). Replace the thermocouple with a new one.
----------------------------------	--

3.8 Measuring Electrostatic Capacities (DT4252, DT4253, DT4255, DT4256)

The capacity of the capacitor is measured.

WARNING



Before measuring, be sure to turn off the power to the measurement circuit. Otherwise, electric shock may occur or the instrument may be damaged.



Do not measure the capacitor which has been charged.

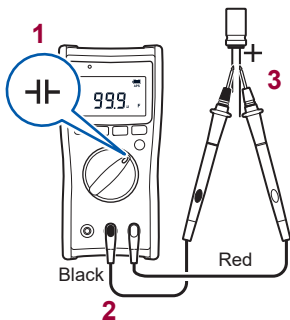

- **When measuring the polar capacitor**
Connect the V terminal (red test lead) to the + terminal of the capacitor and the COM terminal (black test lead) to the - terminal.
- For components on a circuit board, measurement may not be possible due to the effect of the peripheral circuit.

3.9 Measuring Current (DT4252, DT4253, DT4256)

DC/AC current is measured.

DANGER



- Do not input any voltage to the current measurement terminals. Doing so may result in short circuit accidents.
- To avoid electrical accidents, turn off the power to the circuit before measuring and then connect the test leads.

Measuring DC/AC Current

Function

- **μ A** Selected to measure 600.0 μ A DC or less. (DT4253)
- **mA** Selected to measure 60.00 mA DC or less. (DT4253)
The % conversion of 4-20 mA can be checked in the sub display.
- **A** Selected to measure 10 A DC/AC or less. (DT4252, DT4256)
The % conversion of 4-20 mA can be checked in the sub display.
(Only the DT4256)

When measuring an unknown current

Set to the high range (mA for the DT4253).

DT4253

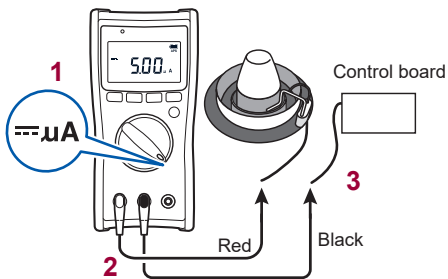

Example: Measuring the current of the burner flame (μA)

The measured current value of the burner flame varies with the input impedance of the instrument.
The μA input impedance of this instrument is approx. 1 k Ω .

DT4252, DT4256

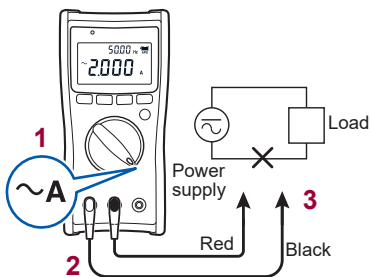

(The position of the rotary switch varies depending on the model.)

4 - 20 mA % conversion (DT4253, DT4256)

The 4 - 20 mA signal of the instrumentation system can be converted to 0% to 100% and checked.

4 mA - 20 mA → 0% - 100%

(An input less than 4 mA or exceeding 20 mA is displayed with [----].)

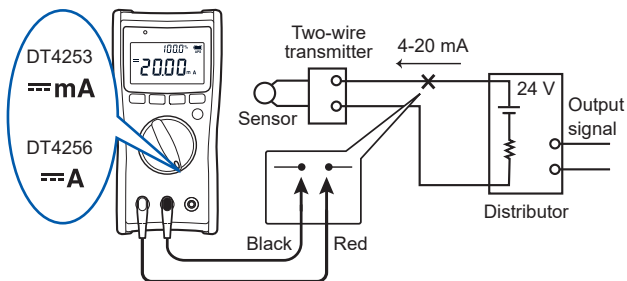

3.10 Measuring AC Current Using Clamp-on Probe (DT4253, DT4255, DT4256)

The current is measured using our optional clamp-on probe (9010-50, 9018-50, 9132-50). To connect to this instrument, the 9704 Conversion Adapter is required. Before using the clamp-on probe, be sure to read the Instruction Manual which accompanies the optional clamp.

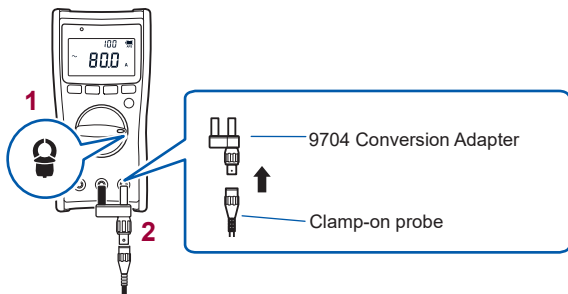

Set the clamp-on probe and the instrument to the same range.

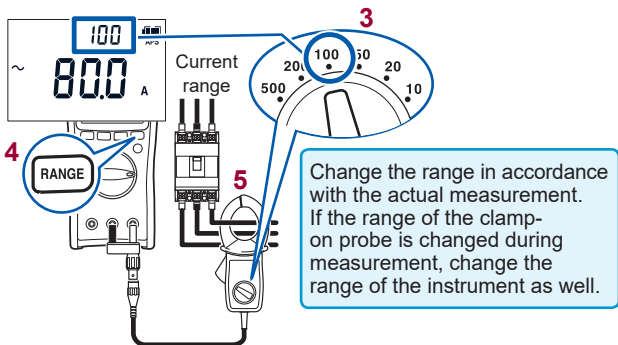

When clamping a cable

Attach the clamp around only one conductor.

Single-phase (2-wire) or three-phase (3-wire) cables clamped together will not produce any reading.

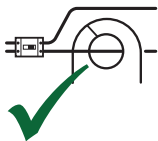

OK

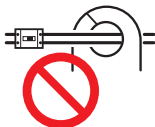

NO

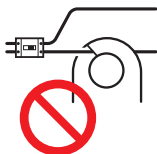

NO

When the measured value and OVER blink

The measured value exceeds the maximum display counts.
Increase the range.

3.11 Checking the Electric Charge (DT4254, DT4255, DT4256)

Whether a power line is energized can be checked easily. If the power line is energized, it is indicated via a buzzer and display. Use this function for coated power lines. The detection may not be made depending on the measurement conditions.

WARNING



To avoid electric shock, do not use the instrument with test leads fixed to the lead holders.

- To check the electric charge properly, do not use the instrument with test leads wrapped around the instrument. The sensitivity of electric charge detection deteriorates.
- Check that the detection function operates normally before use. (p. 41)

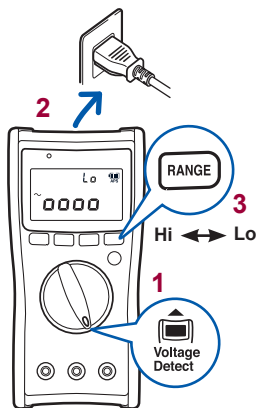

- 1 Select the measurement function.**
- 2 Move the instrument close to the power line.**
- 3 Switch the detection sensitivity.**

When the detection level is exceeded, a buzzer sounds and the red LED lights up.

Detection sensitivity	Detection voltage range
Hi	40 V AC to 600 V AC
Lo	80 V AC to 600 V AC

(The position of the rotary switch varies depending on the model.)

4

Using Instrument Conveniently

4.1 Selecting the Measurement Range

Auto or Manual range can be selected. In the case of measurement where the desired range can be selected, [RANGE:] lights up at the bottom of the display.

- Auto range Sets the optimum range automatically in accordance with the actual measurement.
- Manual range Sets the specific range manually.
(When the relative value (REL) function is enabled, the range cannot be changed.)

Measuring with the auto range



[RANGE: AUTO] lights up.

When the measurement function is switched using the rotary switch, the auto range is enabled.

Measuring with the manual range



Press **RANGE**.

[RANGE: MANUAL] lights up.

Each time **RANGE** is pressed, a higher range is specified. When the key is pressed at the highest range, the lowest range is specified once again.
Example: When the range is 6.000 V to 1000 V
6.000 V → 60.00 V → 600.0 V → 1000 V → 6.000 V

To switch from the manual range to the auto range, press **RANGE** for at least 1 second.

4.2 Retaining the Measured Value

The measured value is retained manually or automatically. (The bar graph is updated.)

- Manually When **HOLD** is pressed, the measured value is retained. (HOLD lights up.)
- Automatically When **HOLD** is pressed and held for at least 1 second, auto hold mode starts (HOLD blinks), and when the measured value stabilizes, it is retained. (HOLD lights up.)

Retaining the measured value manually (HOLD)



To retain the measured value, press **HOLD**.

(HOLD lights up and the measurement value is retained.)

To cancel the hold state, press it again. (HOLD goes off.)

Automatically retaining the measured value when the value stabilizes (AUTO HOLD)

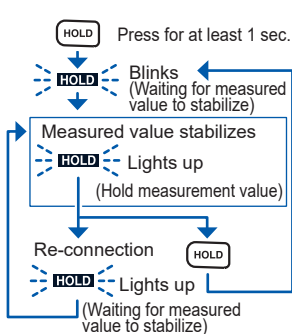

Press **HOLD** for at least 1 second. (HOLD blinks, the instrument is waiting for the measured value to stabilize.)

When the measured value stabilizes, a beeping sound is generated and the value is retained. (HOLD lights up.)

When the test leads are moved away from the measurement object, reconnected again, and the measured value stabilizes, a beeping sound is generated and the new measured value is retained.

When **HOLD** is pressed while HOLD is lit, the instrument returns to the wait state. (HOLD blinks.)

Press **HOLD** for at least 1 second to cancel auto hold mode.

- If the input signal is too small for the relevant range, the measured value cannot be automatically retained.
- The measured value is automatically retained after it remains stable (for approx. 2 seconds) within the stable range.

Conceptual diagram (AC voltage)

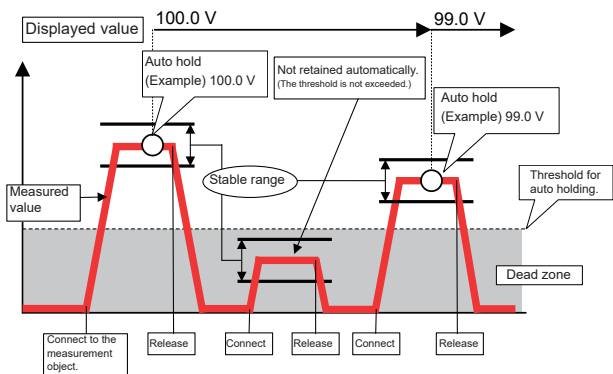

Conditions for auto holding

Function	Stable range for auto holding (Display count)	Threshold for auto holding (Dead zone display count)
AC voltage	120 or less (except 1000 V range) 20 or less (1000 V range)	120 or less (except 1000 V range) 20 or less (1000 V range)
DC voltage ^{*2}	120 or less (except 1000 V range ^{*1}) 20 or less (1000 V range ^{*1})	120 or less (except 1000 V range ^{*1}) 20 or less (1000 V range ^{*1})
AUTO V	120 or less	120 or less
Continuity check	100 or less	4900 or more
Resistance	100 or less	4900 or more
Diode	40 or less	1460 or more
AC (Clamp)	50/100/25/50/100/25/50 or less (each range)	50/100/25/50/100/25/50 or less (each range)
DC (μA)	120 or less	120 or less
DC (mA)	120 or less	120 or less
DC (A)	120 or less (except 10 A range) 20 or less (10 A range)	120 or less (except 10 A range) 20 or less (10 A range)
AC (A)	120 or less (except 10 A range) 20 or less (10 A range)	120 or less (except 10 A range) 20 or less (10 A range)

*1: DT4254 is 1500 V range.

*2: No function is available for the mV range.

4.3 Reducing the Effect of the Noise (FILTER)

WARNING



To avoid electric shock or other personal injury, select the appropriate passband setting when measuring the AC voltage. If an inappropriate frequency is selected, the measured value displayed will not be correct.

As the effect of high-frequency noise can be reduced with the low pass filter (digital filter), this function can be used when measuring the fundamental frequency (AC voltage measurement) on the secondary side of the inverter.

This function can be used when measuring the AC voltage, AC/DC voltage automatic judgment, AC current, and clamp AC current. The passband setting for the low pass filter can be selected.

Example 1 (FILTER: OFF)



Example 2 (FILTER: 100 Hz)



Press .

(Current FILTER setting is displayed.)

Each time  is pressed while the current FILTER setting is displayed, the passband setting is changed.

[OFF]→[100 Hz]→[500 Hz]→[OFF]

- When the desired passband setting is displayed for 2 seconds, the setting is applied and then the measurement display reappears.
- If the FILTER setting is changed, the relative value function (REL) will be canceled.

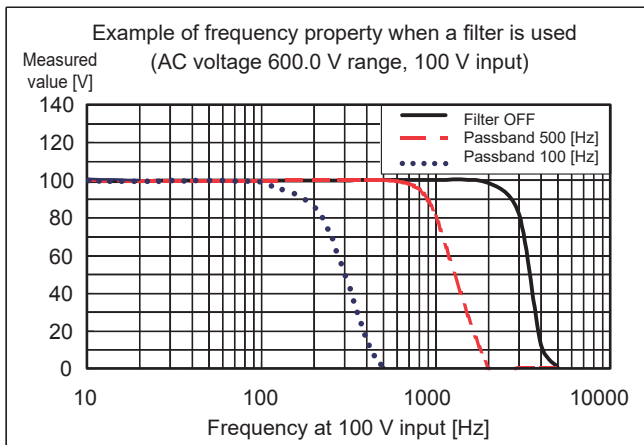

Example: Power frequency on an aircraft or marine vessel is 400 Hz
When voltage is 100 V

	FILTER setting	Displayed value
Normal	OFF	Approx. 100 V
	500 Hz	
Abnormal	100 Hz	Around 0 V

4.4 Checking the Maximum/Minimum/Average

The maximum value (MAX), minimum value (MIN), and average value (AVG) of the measured value can be checked.

When the following measurement function is selected, this function is disabled.

AUTO V, Electric charge detection

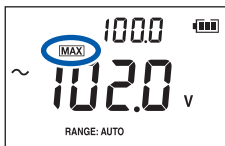

Connect the test leads to the measurement object and press .

Each time the key is pressed, the main display is changed.

[MAX] → [MIN] → [AVG] → [MAX]

The current measured value can be checked in the sub display.



Changing back to the normal display

Press  for at least 1 second.

- The maximum (MAX) and minimum (MIN) values are for the displayed value; they do not relate to peak values such as AC signals.
- When the  key is pressed and the instrument enters the display mode for maximum, minimum, and average values, the display of auto power save (APS) disappears and the APS setting is canceled.

4.5 Checking the Relative Value/ Performing Zero Adjustment

The relative value comparing to the standard value can be checked (relative function).

It can also be used as the zero adjustment function.

Zero adjustment eliminates the influences of the test lead wiring resistance (continuity, resistance measurement) and the wiring capacity (capacitor measurement).

When the following measurement function is selected, this function is disabled.

AUTO V, Diode, Electric charge detection

When the relative function is enabled, the range settings cannot be changed. Effective measuring range of each range are the same, not according to enable/disable of the relative function.

Checking the relative value (REL)

Example 1: DC voltage measurement



When the **standard value** is measured, press **FILTER** for at least 1 second.

(REL lights up.)

The relative value is displayed.

To cancel the state, press it for at least 1 second again.

(REL goes off.)

Example 2: Temperature measurement



(ΔT and T1 light up.)



(ΔT and T2 light up.)

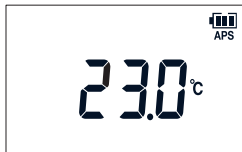

(ΔT goes off.)

When the standard value is measured, press **FILTER** for at least 1 second.

The standard temperature is fixed as T1. The currently measured temperature is displayed as T2 alternately with T1. The temperature difference ΔT (T2 - T1) is displayed in the sub display.

To cancel the state, press **FILTER** for at least 1 second again.

Performing zero adjustment

When performing zero adjustment, the condition of the test leads varies depending on the measurement function.

Perform zero adjustment, referring to the table below.

Measurement function	V, A, Ω , dB	--
Condition of the test leads	Short circuit	Open

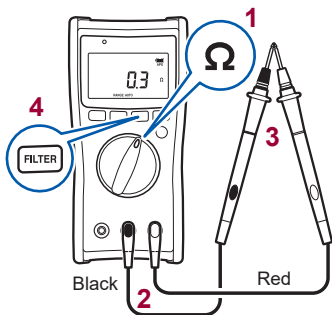

Example 1: Resistance measurement

- 1 Select the measurement function.
- 2 Connect the test leads to the measurement terminals.
- 3 Allow the test leads to short circuit.
- 4 Press **FILTER** for at least 1 second.
(After zero adjustment: 0.0 Ω)
- 5 Measure the resistance.

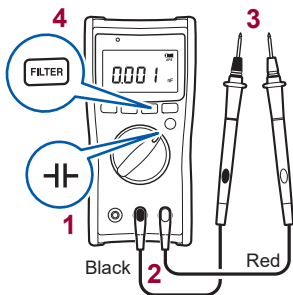

Example 2: Capacitor measurement

- 1 Select the measurement function.
- 2 Connect the test leads to the measurement terminals.
- 3 Allow the test leads to open.
- 4 Press **FILTER** for at least 1 second.
(After zero adjustment: 0.000 μF)
- 5 Measure the capacitor.

4.6 Turning On the Backlight

The backlight can be turned on/off by pressing .

The backlight automatically turns off if the instrument is not operated for approx. 40 seconds.

The automatic backlight deactivation function can be disabled.

(p. 74)

4.7 Using the Auto Power Save (APS)

The auto power save function saves on battery consumption. If the instrument has not been operated for approx. 15 minutes, it enters the sleep mode. When the sleep mode continues for approx. 45 minutes, the power turns off automatically.

In the default setting, the auto power save function is set to enabled. (APS lights up.)

It is also possible to disable the auto power save function.

At 30 seconds before the instrument enters the sleep mode, the APS blinks to indicate its status. To continuously use the instrument, press any key or turn the rotary switch.

Auto power save function

- When the instrument is in the sleep mode, press any key or turn the rotary switch to recover from the sleep mode.
- If the instrument will be used for an extended period of time, disable the auto power save function. (p.74)
- After use, set the rotary switch to OFF. When the instrument is in auto power save, it consumes a small amount of current.

Recovering from a power shutdown

Set the rotary switch to OFF and turn on the power again.

4.8 Using Plus/Minus Judgment Function for Measurement Value (DT4254, DT4255, DT4256)

If the measured DC voltage is less than the following standard value, a buzzer sounds and the red LED lights up.

This function is useful for checking for any incorrect connection of the DC power.

Standard value: -10 V or less

Measurement function: DCV, AUTO V

“Enabling/disabling the Plus/Minus judgment function” (p.75)

4.9 Communicating with PC

Using the optional DT4900-01 Communication Package, it is possible to transmit data to the PC or to control the instrument.

Install the special software on the PC.

(See the Instruction Manual which accompanies with the communication package.)

Attaching the USB cable to the instrument (p. 73)

Connect to the PC.

The virtual COM ports of the PC can be used as the USB interface. The instrument recognizes the COM1 to COM256 virtual ports.

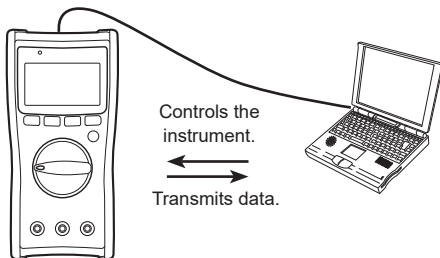

- Communication method: Start-stop system, half-duplex transmission
- Baud rate: 9,600 bps fixed
- Parity: None
- Data bit length: 8 bits
- Delimiter: CR+LF
- Stop bit: 1 bit

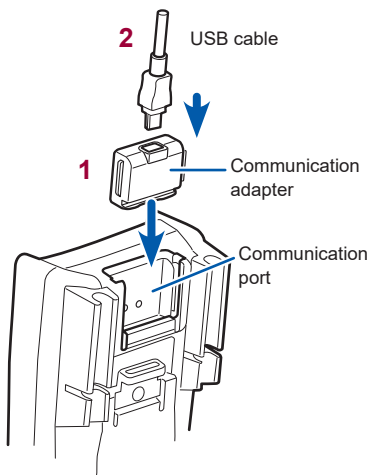

Attaching the communication adapter to the instrument













- 1** Attach the communication adapter.
- 2** Connect the USB cable to the communication adapter.







- Connect the cables, being careful to orient each cable correctly.
- During communication,  appears in the display.
- When  is lit, the operation keys of the instrument is disabled.
- During communication, do not disconnect the USB cable. Disconnecting the cable stops the communication. In that case, a warning is displayed by the PC software. Connect the cable again.
- It is possible to use the instrument while the communication adapter is attached, however, the communication adapter is excluded from the drop-proof.





4.10 Power-on Option Table

The settings in the instrument can be changed or checked. When the power is turned off, all setting changes, except the temperature display unit and plus/minus judgment function are lost. When the operation key is released after changing the setting, the regular display then reappears.

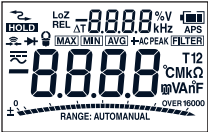
- +  Turn on the power while pressing the operation key.
(Turn the rotary switch from OFF.)

Setting change	Method
Canceling the auto power save function (APS)	 +  (APS goes off.) (See p. 70) 
Buzzer OFF	 +  
Disabling the automatic backlight deactivation	 +  

Setting change	Method
<p>Enabling/ disabling the Plus/Minus judgment function</p>	 <p>The setting will be saved even when the power is turned off. ON and OFF is switched at each operation.</p> <div style="display: flex; justify-content: space-around;"> <div data-bbox="308 329 563 470">  </div> <div data-bbox="586 329 841 470">  </div> </div>
<p>Checking the software version</p>	 (First position from OFF) Example: Ver 1.00 
<p>Displaying all indicators</p>	 (Third position from OFF) Check that there are no missing indicators. If any indicator is missing, stop using the instrument and send it for repair. 

Setting change	Method
Checking the adjustment source	<p data-bbox="315 189 916 240"> +  (Second position from OFF)</p> <p data-bbox="305 254 927 313">FACT: Indicates that the settings have been adjusted by Hioki.</p> <div data-bbox="305 327 574 502"><p data-bbox="429 342 564 378">Rdu </p><p data-bbox="336 393 502 458">FACT</p></div>

Changing the temperature display unit

The units of temperature ($^{\circ}\text{C}$ or $^{\circ}\text{F}$) can be changed.

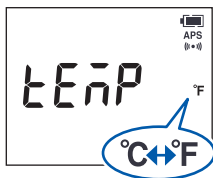





(Display: tEMP)

- 1 Turn on the power while pressing **HOLD** and **MAX/MIN** simultaneously.
- 2 Press and hold **FILTER** and **RANGE** simultaneously.
- 3 Press **RANGE** to change the temperature unit.
- 4 Press and hold **FILTER** to save the setting.
- 5 After turning the power OFF, turn the rotary switch to TEMP and check the temperature unit.

The setting of the temperature unit is retained even after the power is turned off.

5.1 General Specifications

Power supply	LR03 alkaline battery × 4
Battery indicator warning voltage	<ul style="list-style-type: none"> • 5.5 V or more^{*1}  lights up. • Less than 5.0 V to 5.5 V^{*1}  lights up. • Less than 4.5 V to 5.0 V^{*1}  lights up. • Less than 4.0 V to 4.5 V^{*1}  blinks. • Power shutdown at less than 4.0 V^{*1} <p>*1: Error: ±0.1 V</p>
Dimensions	Approx. 84 W × 174 H × 52 D mm (3.31" W × 6.85" H × 2.05" D) (including the holster, stand, and rotary switch)
Mass	Approx. 390 g (13.8 oz.) (with the batteries and holster attached)
Operating environment	Indoors, pollution degree 2, altitude up to 2000 m (6562 ft.)
Operating temperature and humidity	<ul style="list-style-type: none"> • Temperature: <ul style="list-style-type: none"> -25°C to 65°C (-13.0°F to 149.0°F): DT4254, DT4255, DT4256 -10°C to 50°C (14.0°F to 122.0°F): DT4252, DT4253 • Humidity: <ul style="list-style-type: none"> -25°C to 40°C (-13.0°F to 104.0°F): <ul style="list-style-type: none"> 80% RH or less (no condensation) 40°C to 65°C (104.0°F to 149.0°F) : <ul style="list-style-type: none"> reduces linearly to 40°C (104.0°F) 80% RH or less to 65°C (149.0°F) 25% RH or less. (no condensation)
Storage temperature and humidity	<ul style="list-style-type: none"> -30°C to 70°C (-22.0°F to 158.0°F): DT4254, DT4255, DT4256 -30°C to 60°C (-22.0°F to 140.0°F): DT4252, DT4253 80% RH or less (no condensation)
Dustproof and waterproof	IP42 (EN60529)

Drop-proof distance	1 m on concrete (with the holster attached)
Product warranty period	3 years (excluding the measurement accuracy)
PC communication	Digital multimeter ↔ DT4900-01 Communication Package (USB) ↔ PC After a command is sent from the PC, [] lights up and communication begins. After the command is sent from the PC, a response operation is performed.
Accessories	<ul style="list-style-type: none"> • L9207-10 Test Lead • Holster (attached to the instrument, with a test lead holder) • Instruction Manual • LR03 alkaline battery × 4 (not installed in the instrument)
Options	See: “Options (sold separately)” (p. 2)
Replacement parts	<ul style="list-style-type: none"> • DT4253 250 mA/1000 V fuse for current terminal (μA, mA) (Breaking capacity 50 kA AC/30 kA DC Fast-blow type: φ10.3 × 38 mm, HOLLYLAND) • DT4255 630 mA/1000 V fuse for voltage terminal (Breaking capacity 50 kA AC/30 kA DC Fast-blow type: φ10.3 × 38 mm, HOLLYLAND) • DT4252, DT4256 11 A/1000 V fuse for current terminal (A) (Breaking capacity 50 kA AC/30 kA DC Fast-blow type: φ10.3 × 38 mm, HOLLYLAND)
Standards	<ul style="list-style-type: none"> • Safety: EN61010 • EMC: EN61326

5.2 Electrical Characteristics

Noise rejection characteristics NMRR	<ul style="list-style-type: none"> • DCV: -60 dB or more (50 Hz/60 Hz)
Noise rejection characteristics CMRR	<ul style="list-style-type: none"> • DCV: -100 dB or more (DC/50 Hz/60 Hz, 1 kΩ unbalance) • ACV: -60 dB or more (DC/50 Hz/60 Hz, 1 kΩ unbalance)
Response time (Auto range)	<ul style="list-style-type: none"> • Power ON time: Within 2 seconds (When the range does not move until the measured value is displayed on the LCD screen) • DCV: 0.6 to 0.7 seconds (0 V \rightarrow 100 V auto range operation)^{*1, *6} 0.7 to 0.8 seconds (0 V \rightarrow 100 V auto range operation)^{*2, *3, *4, *5, *6} • ACV: 0.6 to 0.7 seconds (0 V \rightarrow 100 V auto range operation)^{*6} • Ω: Approx. 1.0 to 1.1 seconds (Infinity \rightarrow 0 Ω auto range operation)^{*6}
Display update rate	<ul style="list-style-type: none"> • Measured value: 5 times/s (excluding electrostatic capacity, frequency, temperature after the range is fixed)^{*7} 0.05 to 5 times/s (varies depending on the electrostatic capacity)^{*7} 1 to 2 times/s (frequency)^{*7} 1 time/s (temperature)^{*7} • Bar graph: Updated 40 times/s
Dielectric strength	8.54 kV AC sine wave (50 Hz/60 Hz, 60 seconds) (current sensitivity: 2 mA) Between the measurement terminal and chassis
Maximum rated voltage between terminals	V terminal: 1000 V DC (1700 V DC ^{*3}) / 1000 V AC or 2×10^7 V \cdot Hz

*1: DT4252, *2: DT4253, *3: DT4254, *4: DT4255, *5: DT4256

*6: Until the values stabilize within the accuracy specification range.

*7: Measured within the measurement range (excluding range movement).

Maximum rated current between terminals	<ul style="list-style-type: none">• DT4252, DT4256: Current terminal (A): 10 A DC/10 A AC• DT4253: Current terminal (μA, mA): 60 mA DC
Maximum rated voltage between measurement terminals and ground	1000 V AC (Measurement category III) 600 V AC (Measurement category IV) Anticipated transient overvoltage: 8000 V
Rated power voltage	1.5 V DC \times 4 LR03 Alkaline battery \times 4
Maximum rated power	600 mVA (Power voltage 6.0 V, continuity measurement input short-circuited, backlight lit)
Rated power	<ul style="list-style-type: none">• 36 mVA +20% or less (Power voltage 6.0 V, DCV measurement, backlight off)• 12 mVA +20% or less (Power voltage 6.0 V, sleep mode)
Continuous operating time	Approx. 130 hours when backlight is off and LR03 alkaline batteries \times 4 is used. (at 23°C)
Circuit protection (Only the DT4255)	Current-limiting resistance, protective fuse Even when the internal circuit is damaged and short circuit occurs, the short circuit current is controlled using the current-limiting resistance, and the circuit is shut off using the fast-blow fuse.

5.3 Accuracy Table

Guaranteed accuracy period	1 year
Guaranteed accuracy period after adjustment made by Hioki	1 year
Regulated power supply range	4.0 V \pm 0.1 V or more (until the power shutdown)
Accuracy guarantee for temperature and humidity	23°C \pm 5°C (73.0°F \pm 9.0°F), 80%RH or less (no condensation)
Temperature characteristic	<ul style="list-style-type: none"> • “Measurement accuracy \times 0.1/°C” is added (excluding 23°C \pm 5°C (73.0°F \pm 9.0°F)). • For resistance of DT4252 and DT4253 60.00 MΩ range, “Measurement accuracy \times 0.4/°C” is added (excluding 23°C \pm 5°C (73.0°F \pm 9.0°F)).
Other conditions	The accuracy of the two connected L4931 Extension Cable Sets (3 m) is guaranteed.

- rdg. (reading or displayed value): The value currently being measured and displayed on the measuring instrument.
- dgt. (resolution): The smallest displayable unit, i.e., the input value that causes the digital display to show a “1”.

1 AC voltage

Range	Accuracy ^{*1}		Input impedance
	40 to 500 Hz	Over 500 Hz to 1 kHz	
6.000 V	\pm 0.9% rdg. \pm 3 dgt.	\pm 1.8% rdg. \pm 3 dgt.	11.2 M Ω \pm 2.0% 100 pF or less
60.00 V	\pm 0.9% rdg. \pm 3 dgt.	\pm 1.8% rdg. \pm 3 dgt.	10.3 M Ω \pm 2.0% 100 pF or less
600.0 V	\pm 0.9% rdg. \pm 3 dgt.	\pm 1.8% rdg. \pm 3 dgt.	10.2 M Ω \pm 1.5% 100 pF or less
1000 V	\pm 0.9% rdg. \pm 3 dgt.	\pm 1.8% rdg. \pm 3 dgt.	10.2 M Ω \pm 1.5% 100 pF or less

Accuracy Table

- Overload protection: 1100 V DC (1870 V DC²)/1100 V AC or 2×10^7 V • Hz (energized for 1 minute)
Transient overvoltage: 8000 V
- Crest factor: The crest factor is 3 up to 4000 counts and reduces linearly to 2 at 6000 counts.
- Connection method: AC coupling
- Auto range movement threshold: 6000 counts or more for upper range, 540 counts or less for lower range.

*1: The accuracy is specified in 1% or more of the range, however, ± 5 dgt. should be added to 5% or less of the range.

- Accuracy guarantee range for frequency: 40 Hz to 1 kHz (Measured values outside the accuracy guarantee range for frequency are also displayed.)
- For 100 Hz with the filter ON, $\pm 1.5\%$ rdg. is added to the accuracy specification between 40 Hz and 100 Hz and the accuracy is not specified in 100 Hz or more.
- For 500 Hz with the filter ON, $\pm 0.5\%$ rdg. is added to the accuracy specification between 40 Hz and 500 Hz and the accuracy is not specified in 500 Hz or more.

*2: DT4254

2 Frequency

Range	Accuracy	Remarks
99.99 Hz	$\pm 0.1\%$ rdg. ± 1 dgt.	-
999.9 Hz	$\pm 0.1\%$ rdg. ± 1 dgt.	-
9.999 kHz	$\pm 0.1\%$ rdg. ± 1 dgt.	-
99.99 kHz	$\pm 0.1\%$ rdg. ± 1 dgt.	AC voltage only

- Auto range movement threshold: 9999 counts or more for upper range, 900 counts or less for lower range.

Minimum sensitivity voltage (sine wave)

Range	Measurement range	AC voltage range			
		6.000 V	60.00 V	600.0 V	1000 V
99.99 Hz	5.00 Hz to 99.99 Hz ^{*1}	0.600 V or more	6.00 V or more	60.0 V or more	100 V or more
999.9 Hz	100.0 Hz to 999.9 Hz	0.600 V or more	6.00 V or more	60.0 V or more	100 V or more
9.999 kHz	1.000 kHz to 9.999 kHz	0.600 V or more	6.00 V or more	60.0 V or more	100 V or more
99.99 kHz	10.00 kHz to 50.00 kHz	1.800 V or more	12.00 V or more	120.0 V or more	230 V or more
	Over 50.00 kHz to 99.99 kHz	3.000 V or more	24.00 V or more	240.0 V or more	400 V or more

- The voltage input is up to 2×10^7 V · Hz.
- [---] appears when no measurement can be made.

*1: The measurement range from 5.00 Hz is only for the 6.000 V range. The measurement range for other voltage ranges is 40.00 Hz to 99.99 Hz.

Minimum sensitivity current (sine wave)

Range	Measurement range	AC current range		
		600.0 mA	6.000 A	10.00 A
99.99 Hz	40.00 Hz to 99.99 Hz	60.0 mA or more	0.600 A or more	3.00 A or more
999.9 Hz	100.0 Hz to 999.9 Hz	60.0 mA or more	0.600 A or more	3.00 A or more
9.999 kHz	1.000 kHz to 9.999 kHz	60.0 mA or more	0.600 A or more	3.00 A or more

3 DC voltage

Range	Accuracy	Input impedance
600.0 mV	$\pm 0.5\%$ rdg. ± 5 dgt.	11.2 M Ω $\pm 2.0\%$
6.000 V	$\pm 0.3\%$ rdg. ± 5 dgt. ^{*3} / ± 3 dgt. ^{*1, *2}	11.2 M Ω $\pm 2.0\%$
60.00 V	$\pm 0.3\%$ rdg. ± 5 dgt. ^{*3} / ± 3 dgt. ^{*1, *2}	10.3 M Ω $\pm 2.0\%$
600.0 V	$\pm 0.3\%$ rdg. ± 5 dgt. ^{*3} / ± 3 dgt. ^{*1, *2}	10.2 M Ω $\pm 1.5\%$
1000 V ^{*1, *3}	$\pm 0.3\%$ rdg. ± 5 dgt. ^{*3} / ± 3 dgt. ^{*1, *2}	10.2 M Ω $\pm 1.5\%$
1500 V ^{*2} (0 V to 1000 V)	$\pm 0.3\%$ rdg. ± 3 dgt.	10.2 M Ω $\pm 1.5\%$
(1001 V to 1700 V)	$\pm 2.0\%$ rdg. ± 5 dgt.	

- Overload protection: 1100 V DC (1870 V DC^{*2})/1100 V AC or 2×10^7 V \cdot Hz (energized for 1 minute)
- Auto range movement threshold: 6000 counts or more for upper range, 540 counts or less for lower range.

*1: DT4255, DT4256

*2: DT4254

*3: DT4252, DT4253

4 DC voltage (High accuracy 600.0 mV)

Range	Accuracy	Input impedance
600.0 mV	$\pm 0.2\%$ rdg. ± 5 dgt.	10.2 M Ω $\pm 1.5\%$

- Overload protection: 1000 V DC/1000 V AC or 2×10^7 V \cdot Hz (energized for 1 minute)

5 AUTO V

Range	Accuracy ^{*1}		Input impedance
	DC, 40 to 500 Hz	Over 500 Hz to 1 kHz	
600.0 V	±2.0% rdg. ±3 dgt.	±4.0% rdg. ±3 dgt.	900 kΩ ±20% ^{*2} 1800 kΩ ±20% ^{*3}

- Overload protection: 1100 V DC (1870 V DC^{*3})/1100 V AC or 2×10^7 V • Hz (energized for 1 minute)
- Transient overvoltage: 8000 V
- Crest factor: The crest factor is 3 up to 4000 counts and reduces linearly to 2 at 6000 counts.
- Connection method: DC coupling

*1: For AC voltage, the accuracy is specified in 1% or more of the range, however, ±5 dgt. should be added to 5% or less of the range.

- Accuracy guarantee range for frequency: 40 Hz to 1 kHz (Measured values outside the accuracy guarantee range for frequency are also displayed.).
- For 100 Hz with the filter ON, ±1.5% rdg. is added to the accuracy specification between 40 Hz and 100 Hz and the accuracy is not specified in 100 Hz or more.
- For 500 Hz with the filter ON, ±0.5% rdg. is added to the accuracy specification between 40 Hz and 500 Hz and the accuracy is not specified in 500 Hz or more.

*2: DT4253, DT4255, DT4256

*3: DT4254

6 Continuity

Range	Accuracy	Measurement current
600.0 Ω	$\pm 0.7\%$ rdg. ± 5 dgt.	200 μA $\pm 20\%$

- Open circuit voltage: 1.8 V DC or less
- Overload protection: 1000 V DC/1000 V AC or 2×10^7 V \cdot Hz (energized for 1 minute)
Current under overload: Steady state 15 mA or less, transient state 0.8 A or less
- Continuity ON threshold: 25 Ω ± 10 Ω (continuous buzzer sound, red LED lit)
- Continuity OFF threshold: 245 Ω ± 10 Ω
- Response time: Open circuit or short circuit is detected for at least 0.5 ms.
- Accuracy guarantee condition: After zero adjustment has been performed

7 Resistance

Range	Accuracy	Measurement current
600.0 Ω	$\pm 0.7\%$ rdg. ± 5 dgt.	200 μA $\pm 20\%$
6.000 k Ω	$\pm 0.7\%$ rdg. ± 5 dgt. ^{*1} / ± 3 dgt. ^{*2}	100 μA $\pm 20\%$
60.00 k Ω	$\pm 0.7\%$ rdg. ± 5 dgt. ^{*1} / ± 3 dgt. ^{*2}	10 μA $\pm 20\%$
600.0 k Ω	$\pm 0.7\%$ rdg. ± 5 dgt. ^{*1} / ± 3 dgt. ^{*2}	1 μA $\pm 20\%$
6.000 M Ω	$\pm 0.9\%$ rdg. ± 5 dgt. ^{*1} / ± 3 dgt. ^{*2}	100 nA $\pm 20\%$
60.00 M Ω	$\pm 1.5\%$ rdg. ± 5 dgt. ^{*1} / ± 3 dgt. ^{*2}	10 nA $\pm 20\%$

- Open circuit voltage: 1.8 V DC or less
- Overload protection: 1000 V DC/1000 V AC or 2×10^7 V \cdot Hz (energized for 1 minute)
Current under short circuit: 300 μA or less
Current under overload: Steady state 15 mA or less, transient state 0.8 A or less
- Accuracy guarantee condition: After zero adjustment has been performed
- Auto range movement threshold: 6000 counts or more for upper range, 540 counts or less for lower range.

*1: DT4252, DT4253

*2: DT4255, DT4256

8 Electrostatic capacity

Range	Accuracy	Charging current
1.000 μF	$\pm 1.9\%$ rdg. ± 5 dgt.	10 n/100 n/1 $\mu\text{A} \pm 20\%$
10.00 μF	$\pm 1.9\%$ rdg. ± 5 dgt.	100 n/1 $\mu\text{A} \pm 20\%$
100.0 μF	$\pm 1.9\%$ rdg. ± 5 dgt.	1 $\mu\text{A} \pm 20\%$
1.000 mF	$\pm 1.9\%$ rdg. ± 5 dgt.	10 $\mu\text{A} \pm 20\%$
10.00 mF	$\pm 5.0\%$ rdg. ± 20 dgt.	100 $\mu\text{A} \pm 20\%$

- Open circuit voltage: 1.8 V DC or less
- Overload protection: 1000 V DC/1000 V AC or 2×10^7 V \cdot Hz (energized for 1 minute)
Current under short circuit: 300 μA or less
Current under overload: Steady state 15 mA or less, transient state 0.8 A or less
- Maximum count for each range: 1100 (1000 for 10.00 mF)
- Auto range movement threshold: 1100 counts or more for upper range, 100 counts or less for lower range.

9 Diode

Range	Accuracy	Measurement current
1.500 V	$\pm 0.5\%$ rdg. ± 5 dgt. ^{*1} / ± 8 dgt. ^{*2}	0.5 mA $\pm 20\%$

- Open circuit voltage: 5.0 V DC or less ,voltage drop due to battery consumption
- Overload protection: 1000 V DC/1000 V AC or 2×10^7 V \cdot Hz (energized for 1 minute)
Current under short circuit: 0.7 mA or less
Current under overload: Steady state 15 mA or less, transient state 0.8 A or less
- During the forward connection, an intermittent buzzer sounds (threshold: 0.15 V to 1.5 V) and the red LED blinks
- A continuous buzzer sounds and the red LED lights up at 0.15 V or less.

*1: DT4252, DT4253, DT4256

*2: DT4255

10 Temperature

Thermocouple type	Range	Accuracy ^{*1}
K	-40.0°C to 400.0°C	±0.5% rdg. ±2°C
	-40.0°F to 752.0°F ^{*2}	±0.5% rdg. ±3.6°F

- Overload protection: 1000 V DC/1000 V AC or 2×10^7 V • Hz (energized for 1 minute)
Current under overload: Steady state 15 mA or less, transient state 0.8 A or less
- The DT4910 Thermocouples (K) are used.
- The accuracy does not include the error of the DT4910 Thermocouples (K).
- Display update rate: 1 time/s (including disconnection check)

*1: In an environment where the temperature of the instrument is $\pm 1^\circ\text{C}$ and stable, the accuracy is specified.

Standard contact temperature compensation stability time: 120 minutes (When the instrument environmental temperature changes quickly from 50°C to 23°C (122.0°F to 73.4°F .)

*2: The °F display is activated using a special instrument operation.

11 AC Current (clamp sensor)

Range	Accuracy (only the instrument) ^{*1}	Conversion rate
	40 Hz to 1 kHz	
10.00 A	±0.9% rdg. ±3 dgt.	0.05 A/mV
20.00 A	±0.9% rdg. ±3 dgt.	0.10 A/mV
50.0 A	±0.9% rdg. ±3 dgt.	0.25 A/mV
100.0 A	±0.9% rdg. ±3 dgt.	0.5 A/mV
200.0 A	±0.9% rdg. ±3 dgt.	1.0 A/mV
500 A	±0.9% rdg. ±3 dgt.	2.5 A/mV
1000 A	±0.9% rdg. ±3 dgt.	5 A/mV

- Input impedance: $1\text{ M}\Omega \pm 20\%$ or less, 1000 pF or less
- The 9010-50, 9018-50, or 9132-50 clamp-on probe is used.
- The accuracy does not include the error of the clamp-on probe.
- Crest factor: 3 or less

- Connection method: DC coupling

*1: The accuracy is specified in 1% or more of the range, however, ± 5 dgt. should be added to 5% or less of the range.

- Accuracy guarantee range for frequency: 40 Hz to 1 kHz (Measured values outside the accuracy guarantee range for frequency are also displayed.)
- For 100 Hz with the filter ON, $\pm 1.5\%$ rdg. is added to the accuracy specification between 40 Hz and 100 Hz and the accuracy is not specified in 100 Hz or more.
- For 500 Hz with the filter ON, $\pm 0.5\%$ rdg. is added to the accuracy specification between 40 Hz and 500 Hz and the accuracy is not specified in 500 Hz or more.

12 DC Current (μA)

Range	Accuracy	Input impedance
60.00 μA	$\pm 0.8\%$ rdg. ± 5 dgt.	1 k Ω $\pm 5\%$
600.0 μA	$\pm 0.8\%$ rdg. ± 5 dgt.	1 k Ω $\pm 5\%$

- Overload protection: 250 mA/1000 V fuse, breaking capacity 50 kAAC/30 kADC
- Auto range movement threshold: 6000 counts or more for upper range, 540 counts or less for lower range.

13 DC Current (mA)

Range	Accuracy	Input impedance
6.000 mA	$\pm 0.8\%$ rdg. ± 5 dgt.	15 Ω $\pm 40\%$
60.00 mA	$\pm 0.8\%$ rdg. ± 5 dgt.	15 Ω $\pm 40\%$

- Overload protection: 250 mA/1000 V fuse, breaking capacity 50 kAAC/30 kADC
- Auto range movement threshold: 6000 counts or more for upper range, 540 counts or less for lower range.

14 DC Current (A)

Range	Accuracy	Input impedance
60.00 mA ^{*2}	±1.8% rdg. ±15 dgt.	35 mΩ ±30%
600.0 mA ^{*2}	±0.9% rdg. ±5 dgt.	35 mΩ ±30%
6.000A	±0.9% rdg. ±5 dgt. ^{*1} /±3 dgt. ^{*2}	35 mΩ ±30%
10.00A	±0.9% rdg. ±5 dgt. ^{*1} /±3 dgt. ^{*2}	35 mΩ ±30%

- Overload protection: 11 A/1000 V fuse, breaking capacity 50 kA AC/30 kA DC
- Auto range movement threshold: 6000 counts or more for upper range, 540 counts or less for lower range.

*1: DT4252

*2: DT4256

15 AC Current (A)

Range	Accuracy ^{*1}		Input impedance
	40 to 500 Hz	Over 500 Hz to 1 kHz	
600.0 mA ^{*2}	±1.4% rdg. ±5 dgt.	±1.8% rdg. ±5 dgt.	35 mΩ ±30%
6.000 A	±1.4% rdg. ±3 dgt.	±1.8% rdg. ±3 dgt.	35 mΩ ±30%
10.00 A	±1.4% rdg. ±3 dgt.	±1.8% rdg. ±3 dgt.	35 mΩ ±30%

- Overload protection: 11 A/1000 V fuse, breaking capacity 50 kA AC/30 kA DC
- Crest factor: The crest factor is 3 up to 4000 counts and reduces linearly to 2 at 6000 counts (except 10.00 A range), 3 or less (10.00 A range).
- Connection method: DC coupling
- Auto range movement threshold: 6000 counts or more for upper range, 540 counts or less for lower range.

*1: The accuracy is specified in 1% or more of the range, however, ±5 dgt. should be added to 300 counts or less.

- Accuracy guarantee range for frequency: 40 Hz to 1 kHz (Measured values outside the accuracy guarantee range for frequency are also displayed.).

- For 100 Hz with the filter ON, $\pm 1.5\%$ rdg. is added to the accuracy specification between 40 Hz and 100 Hz and the accuracy is not specified in 100 Hz or more.
- For 500 Hz with the filter ON, $\pm 0.5\%$ rdg. is added to the accuracy specification between 40 Hz and 500 Hz and the accuracy is not specified in 500 Hz or more.

*2: DT4256

16 Electric charge detection

Range (detection sensitivity)	Detection voltage range* ¹	Detection target frequency
Hi	40 V AC to 600 V AC	50 Hz/60 Hz
Lo	80 V AC to 600 V AC	50 Hz/60 Hz

- During voltage detection, a continuous buzzer sounds and the red LED lights up.

*1: In contact with the insulated wire that is equivalent to $IV2 \text{ mm}^2$.

6

Maintenance and Service

6.1 Repair, Inspection, and Cleaning

DANGER



Customers are not allowed to modify, disassemble, or repair the instrument.

Doing so may cause fire, electric shock, or injury.

Calibrations

IMPORTANT

Periodic calibration is necessary in order to ensure that the instrument provides correct measurement results of the specified accuracy.

The calibration frequency varies depending on the status of the instrument or installation environment. We recommend that the calibration frequency is determined in accordance with the status of the instrument or installation environment and that you request that calibration be performed periodically.

Cleaning

- To clean the instrument, wipe it gently with a soft cloth moistened with water or mild detergent.
- Wipe the display gently with a soft, dry cloth.

IMPORTANT

Never use solvents such as benzene, alcohol, acetone, ether, ketones, thinners or gasoline, as they can deform and discolor the case.

Disposal

Handle and dispose of the instrument in accordance with local regulations.

6.2 Troubleshooting

- When a malfunction of the instrument is suspected, check the information in “Before sending the instrument for repair” and then, if necessary, contact your authorized Hioki distributor or reseller.
- When sending the instrument for repair, remove the batteries and pack it carefully to prevent damage during transportation. Include cushioning material so the instrument cannot move within the package. Be sure to include details of the problem. Hioki cannot be responsible for damage that occurs during transportation.

Before sending the instrument for repair

Symptom	Check and/or remedy
Nothing appears in the display. Or the display disappears after a short time.	Check that the batteries are not exhausted. Replace with new batteries. (p. 26)
	Check that the auto power save function has not been activated. Check the setting of the auto power save function. (p. 70)

Symptom	Check and/or remedy
<p>The measurement value does not appear. Even after the measurement, 0 (zero) still appears. Even after short circuit of the probe, the measured value does not appear. Zero adjustment is not possible.</p>	<p>If the measured current value does not appear, check that the fuse is not blown. Check method: "Check that the fuse is not broken." (p. 40) If the fuse is blown, replace it with the specified fuse. (p. 100)</p> <p>If the measured current value does not appear, check that the fuse holder is not deformed. When removing the fuse, the holder is deformed if excessive force is applied. Pinch it with needle-nose pliers and restore the shape of the fuse holder.</p> <p>Check that the test lead is not broken. Perform the continuity check to confirm the continuity of the test leads. (p. 38) If the test lead is broken, replace the lead.</p> <ul style="list-style-type: none"> • Check that the test leads have been inserted at the ends. • Check that the measurement method is correct. <p>If no problems have been found, the instrument may be malfunctioning. Send the instrument for repair.</p>
<p>The display does not stabilize and the value fluctuates; it is difficult to read the value.</p>	<p>Check that the input signal is within the input range for the instrument. If there is any influence from noise, use the filter function of the instrument. (p. 64)</p>
<p>"----" appears in the display.</p>	<p>"----" appears when the rotary switch position is not confirmed. Set the rotary switch to the proper position.</p>
<p>Turning on the power brings up the error display. When nothing is connected, the error display appears.</p>	<p>Reset the instrument. If the same symptom still occurs even after resetting the instrument, send the instrument for repair.</p>

Other inquiries

Question	Solution
Would like to perform zero adjustment.	Using the relative value display function, zero adjustment can be performed. (p. 69)
Would like to replace the fuse. Would like to know how to obtain the fuse.	The fuse can be purchased via authorized Hioki distributor or reseller.
Can rechargeable batteries be used?	Rechargeable batteries can be used. However, the discharge characteristic of these batteries is different from that of alkaline batteries. Be aware that the remaining battery power display does not function properly.
Would like to control multiple instruments with 1 PC.	To communicate with the instrument, the optional DT4900-01 Communication Package is required. It is possible to control multiple instruments via USB ports.
The instrument cannot communicate with the PC.	<ul style="list-style-type: none"> • Is the communication setting between the instrument and the PC correct? • Are the baud rate and parity check set correctly? (p. 72) • Is the USB cable connected correctly? (p. 72) • Are the light receiving and emitting parts clean?
Would like to know commands. Would like to perform communication using own software.	To communicate with the instrument, the optional DT4900-01 Communication Package is required. For details on commands, see the communication specifications in the CD accompanied by the communication package. These can also be downloaded from our Internet website.

6.3 Error Display

Error display	Description	Solution
Err 001	ROM error Program	When the error appears in the display, it is necessary to repair the instrument. Contact your authorized Hioki distributor or reseller.
Err 002	ROM error Adjustment data	
Err 004	EEPROM error Memory data	
Err 005	ADC error Hardware malfunction	

6.4 Replacing Fuses

If a fuse is blown, replace it with a new one as follows.

For details on how to check that the fuse is blown, see “3 Check that the fuse is not broken.” (p. 40).

WARNING



Replace the fuse only with one of the specified type, characteristics, rated current, and rated voltage.

Do not use fuses other than those specified (especially, do not use a fuse with higher-rated current) or do not short circuit and use the fuse holder. Doing so may damage the instrument and result in personal injury.

Specified fuses

	Rating	Specifications
For μ A/mA terminal (DT4253)	250 mA/ 1000 V	Manufacturer: HOLLYLAND Breaking characteristic: Fast-blow type Breaking capacity: 50 kAAC/ 30 kADC Size: ϕ 10.3 mm \times 38 mm
For V terminal (DT4255)	630 mA/ 1000 V	
For A terminal (DT4252, DT4256)	11 A/ 1000 V	

The fuses can be purchased via authorized Hioki distributor or reseller.

When removing the fuse, do not apply excessive force on the fuse holder. Deformation of the fuse holder could result in poor contact between the fuse and holder, making measurement impossible.

⚠ CAUTION



When replacing the fuse, do not allow foreign matter to enter the instrument. It may cause a malfunction. Do not remove the fuse using the tip of test lead L9207-10 supplied with the instrument. The tip of the test lead may bend.

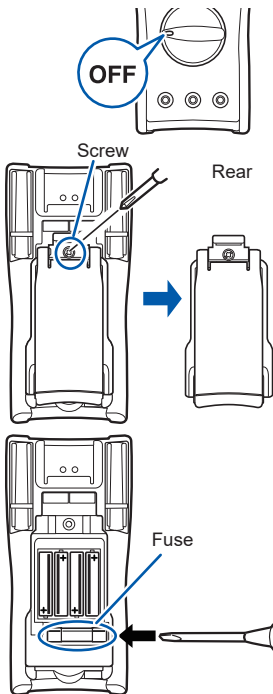

- 1** Remove the test leads from the instrument.
- 2** Set the rotary switch to OFF.
- 3** Using a Phillips screwdriver, remove the screw (1 location) from the battery cover.
- 4** Remove the battery cover.
- 5** Replace the fuse.
- 6** Reattach the battery cover.
- 7** Secure the cover with the screw.

Appendix

Appx. 1 RMS and Average

Difference between the RMS and Average

When converting AC to RMS, 2 methods are available, “True RMS method (True RMS indication)” and “Average method (Average rectifying RMS indication)”.

In the case of the sine wave where no skew is included, the same values are indicated in both methods. However, if the waveform is skewed, a difference occurs between the 2 methods.

The true RMS method is applied to this instrument.

The true RMS method determines RMS values of AC signals, including harmonic components within the accuracy guarantee frequency range, and display them.

In the average method, the input waveform is handled as a sine wave where no skew is included (only single frequency). The average of the AC signal is obtained, converted to the RMS, and then displayed. If the waveform is skewed, a greater measurement error occurs.

Measurement example	True RMS	Average rectifying
100 V sine wave	100 V	100 V
100 V square wave	100 V	111 V

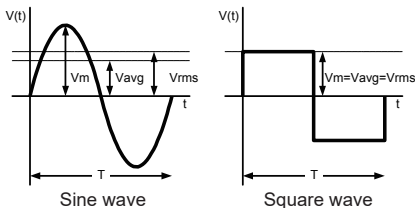

V_m : Maximum value, V_{avg} : Average value, V_{rms} : RMS, T : Time period

Warranty Certificate

HIOKI

Model	Serial number	Warranty period Three (3) years from date of purchase (___ / ___)
-------	---------------	--

Customer name: _____

Customer address: _____

Important

- Please retain this warranty certificate. Duplicates cannot be reissued.
- Complete the certificate with the model number, serial number, and date of purchase, along with your name and address. The personal information you provide on this form will only be used to provide repair service and information about Hioki products and services.

This document certifies that the product has been inspected and verified to conform to Hioki's standards.

Please contact the place of purchase in the event of a malfunction and provide this document, in which case Hioki will repair or replace the product subject to the warranty terms described below.

Warranty terms

- The product is guaranteed to operate properly during the warranty period (three [3] years from the date of purchase).
If the date of purchase is unknown, the warranty period is defined as three (3) years from the date (month and year) of manufacture (as indicated by the first four digits of the serial number in YYYY format).
- If the product came with an AC adapter, the adapter is warranted for one (1) year from the date of purchase.
- The accuracy of measured values and other data generated by the product is guaranteed as described in the product specifications.
- In the event that the product or AC adapter malfunctions during its respective warranty period due to a defect of workmanship or materials, Hioki will repair or replace the product or AC adapter free of charge.
- The following malfunctions and issues are not covered by the warranty and as such are not subject to free repair or replacement:
 - 1. Malfunctions or damage of consumables, parts with a defined service life, etc.
 - 2. Malfunctions or damage of connectors, cables, etc.
 - 3. Malfunctions or damage caused by shipment, dropping, relocation, etc., after purchase of the product
 - 4. Malfunctions or damage caused by inappropriate handling that violates information found in the instruction manual or on precautionary labeling on the product itself
 - 5. Malfunctions or damage caused by a failure to perform maintenance or inspections as required by law or recommended in the instruction manual
 - 6. Malfunctions or damage caused by fire, storms or flooding, earthquakes, lightning, power anomalies (involving voltage, frequency, etc.), war or unrest, contamination with radiation, or other acts of God
 - 7. Damage that is limited to the product's appearance (cosmetic blemishes, deformation of enclosure shape, fading of color, etc.)
 - 8. Other malfunctions or damage for which Hioki is not responsible
- The warranty will be considered invalidated in the following circumstances, in which case Hioki will be unable to perform service such as repair or calibration:
 - 1. If the product has been repaired or modified by a company, entity, or individual other than Hioki
 - 2. If the product has been embedded in another piece of equipment for use in a special application (aerospace, nuclear power, medical use, vehicle control, etc.) without Hioki's having received prior notice
- If you experience a loss caused by use of the product and Hioki determines that it is responsible for the underlying issue, Hioki will provide compensation in an amount not to exceed the purchase price, with the following exceptions:
 - 1. Secondary damage arising from damage to a measured device or component that was caused by use of the product
 - 2. Damage arising from measurement results provided by the product
 - 3. Damage to a device other than the product that was sustained when connecting the device to the product (including via network connections)
- Hioki reserves the right to decline to perform repair, calibration, or other service for products for which a certain amount of time has passed since their manufacture, products whose parts have been discontinued, and products that cannot be repaired due to unforeseen circumstances.

HIOKI E.E. CORPORATION

<http://www.hioki.com>

18-07 EN-3

HIOKI

<http://www.hioki.com>



**All regional
contact
information**

HEADQUARTERS

81 Koizumi
Ueda, Nagano 386-1192 Japan

HIOKI EUROPE GmbH

Rudolf-Diesel-Strasse 5
65760 Eschborn, Germany
hioki@hioki.eu

1908 EN

Edited and published by HIOKI E.E. CORPORATION

Printed in Japan

- CE declarations of conformity can be downloaded from our website.
- Contents subject to change without notice.
- This document contains copyrighted content.
- It is prohibited to copy, reproduce, or modify the content of this document without permission.
- Company names, product names, etc. mentioned in this document are trademarks or registered trademarks of their respective companies.