

Instruction Manual

**HI 83748
TARTARIC ACID
ISM
for wine analysis**

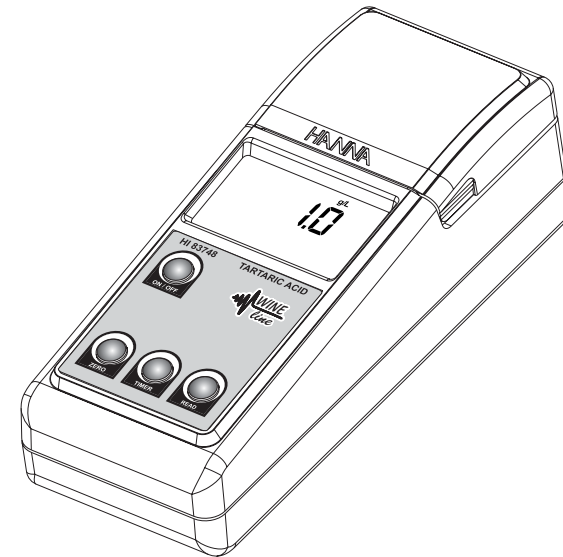

www.hannainst.com

MAN83748R3 04/06



This Instrument is in
Compliance with the CE Directives

Dear Customer,

Thank you for choosing a Hanna product. This manual will provide you with the necessary information for the correct use of the instrument. Please read it carefully before using the meter. If you need additional technical information, do not hesitate to e-mail us at tech@hannainst.com.

This instrument is in compliance with **CE** directives.

TABLE OF CONTENTS

PRELIMINARY EXAMINATION	3
GENERAL DESCRIPTION	4
SPECIFICATIONS	5
PRECISION AND ACCURACY	5
PRINCIPLE OF OPERATION	6
ABBREVIATIONS	7
FUNCTIONAL DESCRIPTION	8
GUIDE TO DISPLAY CODES	9
GENERAL TIPS FOR AN ACCURATE MEASUREMENT	11
MEASUREMENT PROCEDURE	13
BATTERIES REPLACEMENT	16
ACCESSORIES	16
CE DECLARATION OF CONFORMITY	17
WARRANTY	17
HANNA LITERATURE	18
USER NOTES	19

USER NOTES

Date	Tartaric Acid Value (g/L)	Notes

All rights are reserved. Reproduction in whole or in part is prohibited without the written consent of the copyright owner, Hanna Instruments Inc., Woonsocket, Rhode Island, 02895, USA.

HANNA LITERATURE

Hanna publishes a wide range of catalogs and handbooks for an equally wide range of applications. The reference literature currently covers areas such as:

- Water Treatment
- Process
- Swimming Pools
- Agriculture
- Food
- Laboratory

and many others. New reference material is constantly being added to the library.

For these and other catalogs, handbooks and leaflets contact your dealer or the Hanna Customer Service Center nearest to you. To find the Hanna Office in your vicinity, check our home page at www.hannainst.com.

PRELIMINARY EXAMINATION

Please examine this product carefully. Make sure that the instrument is not damaged. If any damage occurred during shipment, please notify your Dealer.

Each HI 83748 Ion Selective Meter is supplied complete with:

- Two sample cuvetts and caps
- Reagents for 5 tests (HI 83748A-O, HI 83748B-O)
- One 200 μ L automatic pipette with Instruction Sheet
- Two plastic tips for 200 μ L automatic pipette
- One 5 mL syringe with tip
- 12 VDC transformer (HI 710005 or HI 710006)
- Four 1,5V AA batteries
- Tissue for wiping cuvetts
- Instruction manual
- Instrument Quality Certificate
- Rigid carrying case

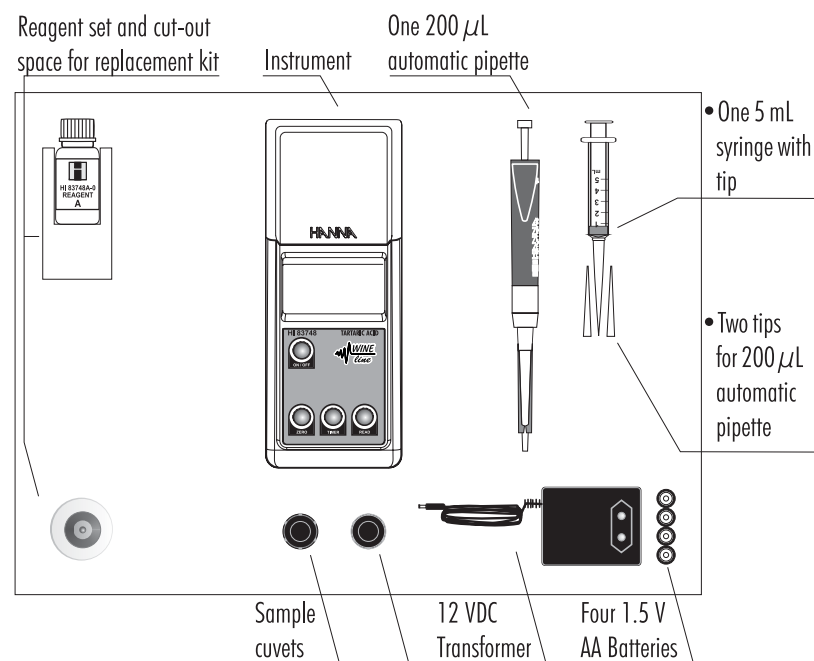

Note: save all packing material until you are sure that the instrument works correctly. Any defective item must be returned in its original packing.

Any

GENERAL DESCRIPTION

The **HI 83748** is an auto-diagnostic portable microprocessor meter that benefits from Hanna's years of experience as a manufacturer of analytical instruments. It has an advanced optical system based on a special tungsten lamp and a narrow band interference filter that allows most accurate and repeatable readings. All instruments are factory calibrated.

The auto-diagnostic feature of this meter ensures always optimal measurement conditions to ensure most precise readings. The light level is automatically adjusted each time a zero-measurement is made, and the temperature of the lamp is controlled to avoid overheating.

SIGNIFICANCE OF USE

Tartaric acid and tartrate are playing an important role in the stability of wines. They can be present in wine and juice in various forms, like tartaric acid (H₂T), potassium bi-tartrate (KHT) or calcium tartrate (CaT). The ratio of these depends mainly on the pH of the wine. The percent of tartrate present as bitartrate (HT-) is maximum at pH 3.7.

The formation of crystalline deposits (tartrate casse) is a phenomenon of wine aging but does not meet customer acceptance. It is therefore important to test for, and to reduce potential of bottle precipitation; for example by adjusting the pH of the wine that significantly influences the potential of casse formation.

Potassium concentrations in wine can range from 600 to 2500 ppm in certain red wines. Although the potassium bi-tartrate is soluble in water, alcohol and low temperatures decrease its solubility. Especially during the alcoholic fermentation potassium bi-tartrate becomes increasingly insoluble resulting in super-saturation and precipitation. The KHT stability can be restored by chilling (with or without seeding). Wines with initial pH values below 3.65 can show a reduction in pH during cold stabilization because of generation of one free proton for each KHT precipitated. The pH may drop as much as 0.2 pH units. For wines at higher pH than 3.7 the pH shifts to a higher pH.

Calcium concentrations can range from 6 to 165 ppm and may complex with tartrate or oxalate to form crystalline precipitates. Calcium tartrate instabilities occur normally from 4 to 7 months after fermentation and are temperature independent.

Sulphates, proteins, gum and poly-phenols can form stable complexes with tartrate thus inhibiting case formation. The complexes are mainly between poly-phenols and tartaric acid in red, and proteins in white wine. This explains why, as pigment polymerization occurs, the holding capacity of tartaric acid diminishes, resulting in delayed casse. The sulfate instead does complex with potassium from 50% in white wines up to 100% in red ones.

Tartaric acid concentrations in wine range normally from 1.5 to 4.0 g/L. This acid concentration may not be confused with total or titratable acidity of wines that are often expressed in tartaric acid content too. Although it is the tartaric acid that is the predominantly present acid (up to 60% of the total acidity), others like malic, citric and several volatile acids do give a significant contribution to total acidity.

CE DECLARATION OF CONFORMITY

Recommendations for Users

Before using these products, make sure that they are entirely suitable for your specific application and for the environment in which they are used.

Operation of these instruments may cause unacceptable interferences to other electronic equipments, this requiring the operator to take all necessary steps to correct interferences.

Any variation introduced by the user to the supplied equipment may degrade the instruments' EMC performance.

To avoid damages or burns, do not put the instrument in microwave ovens. For yours and the instrument safety do not use or store the instrument in hazardous environments.

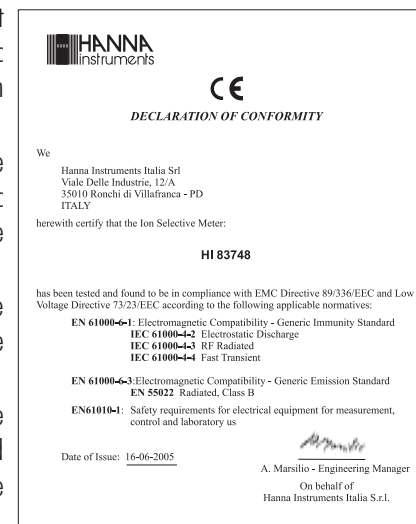

WARRANTY

HI 83748 is warranted for two years against defects in workmanship and materials when used for its intended purpose and maintained according to the instructions.

This warranty is limited to repair or replacement free of charge.

Damages due to accident, misuse, tampering or lack of prescribed maintenance are not covered.

If service is required, contact your dealer. If under warranty, report the model number, date of purchase, serial number and the nature of the failure. If the repair is not covered by the warranty, you will be notified of the charges incurred.

If the instrument is to be returned to Hanna Instruments, first obtain a Returned Goods Authorization Number from the Customer Service Department and then send it with shipment costs prepaid. When shipping any instrument, make sure it is properly packaged for complete protection.

To validate your warranty, fill out and return the enclosed warranty card within 14 days from the date of purchase.

Hanna Instruments reserves the right to modify the design, construction and appearance of its products without advance notice.

BATTERIES REPLACEMENT

Battery replacement must only take place in a non-hazardous area.

The blinking “” will appear when the batteries power gets low.

When batteries are completely discharged, “0% bAtt” will appear and after two seconds the instrument is switched off.

Remove the battery cover from the bottom of the instrument and change the old batteries with 4 fresh 1.5V batteries, paying attention to the correct polarity. Replace the cover.

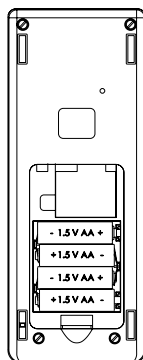

ACCESSORIES

REAGENT SETS

HI 83748-20 Tartaric Acid reagents set for wine (20 tests)

OTHER ACCESSORIES

- HI 740027P 1.5V AA batteries (10 pcs)
- HI 731318 Tissue for wiping cuvetts (4 pcs)
- HI 731321 Glass cuvetts (4 pcs)
- HI 731325W Caps for cuvetts (4 pcs)
- HI 93703-50 Cuvetts cleaning solution (230 mL)
- HI 740226 5 mL graduated syringe
- HI 731340 200 µL automatic pipette
- HI 731350 Plastic tips for 200 µL automatic pipette (25 pcs)

SPECIFICATIONS

Range	0.0-5.0 g/L
Resolution	0.1 g/L
Precision	SD \pm 0.1 g/L @ 2.0 g/L
Light Source	Tungsten lamp with narrow band interference filter @ 525 nm
Light Detector	Silicon Photocell
Method	The reaction between Tartaric Acid and the reagents causes a yellow/orange red tint in the sample.
Environment	0 to 50°C (32 to 122°F); max 95% RH non-condensing
Battery Type	4 x 1,5 volt AA batteries / 12 to 20 VDC through voltage adapter
Dimensions	225 x 85 x 80 mm (8.7 x 3.3 x 3.1")
Weight	500 g (17,6 oz.)

REQUIRED REAGENTS

<u>Code</u>	<u>Description</u>	<u>Quantity/test</u>
HI 83748A-0	Tartaric Acid Reagent A	5 mL
HI 83748B-0	Tartaric Acid Reagent B	6 drops

PRECISION AND ACCURACY

Precision is how closely repeated measurements agree with each other. Precision is usually expressed as standard deviation (SD). Accuracy is defined as the nearness of a test result to the true value.

Although good precision suggests good accuracy, precise results can be inaccurate. The figure explains these definitions.

In a laboratory using a standard solution of 2.0 g/L tartaric acid and a representative lot of reagent, an operator obtained with a single instrument a standard deviation of 0.1 mg/L.

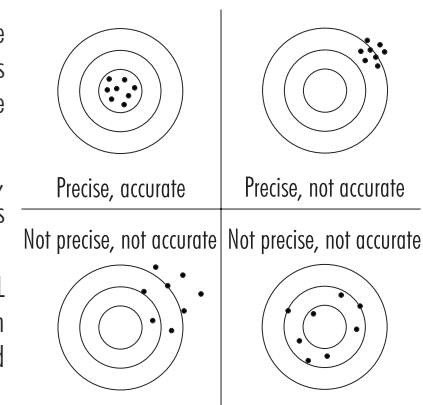

PRINCIPLE OF OPERATION

Absorption of Light is a typical phenomenon of interaction between electromagnetic radiation and matter. When a light beam crosses a substance, some of the radiation may be absorbed by atoms, molecules or crystal lattices.

If pure absorption occurs, the fraction of light absorbed depends both on the optical path length through the matter and on the physical-chemical characteristics of the substance according to the Lambert-Beer Law:

$$-\log \frac{I}{I_0} = \epsilon_{\lambda} c d$$

or

$$A = \epsilon_{\lambda} c d$$

Where:

- $-\log \frac{I}{I_0}$ = Absorbance (A)
- I_0 = intensity of incident light beam
- I = intensity of light beam after absorption
- ϵ_{λ} = molar extinction coefficient at wavelength λ
- c = molar concentration of the substance
- d = optical path through the substance

Therefore, the concentration "c" can be calculated from the absorbance of the substance as the other factors are known.

Photometric chemical analysis is based on the possibility to develop an absorbing compound from a specific chemical reaction between sample and reagents. Given that the absorption of a compound strictly depends on the wavelength of the incident light beam, a narrow spectral bandwidth should be selected as well as a proper central wavelength to optimize measurements.

The optical system of Hanna's **HI 83000** series colorimeters is based on special subminiature tungsten lamps and narrow-band interference filters to guarantee both high performance and reliable results.

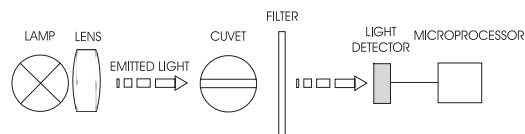

Block diagram (optical layout)

- Press **TIMER** and the instrument will show the countdown or, alternatively, wait for 60 minutes. At the end an acoustic signal alerts the user that the countdown has finished.

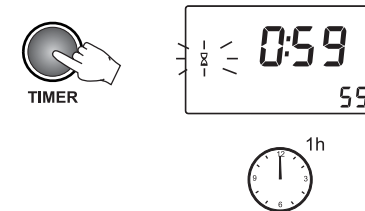

- Press **READ** and the display will show "----" during measurement.

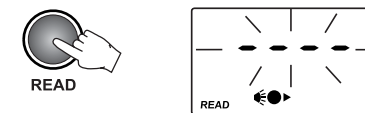

- The instrument directly displays concentration in g/L (ppt) of tartaric acid on the Liquid Crystal Display.

- Place the cuvet into the holder and close the lid.

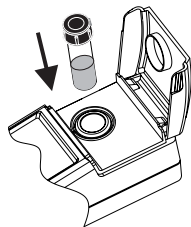

- Press ZERO and “----” will blink on the display.

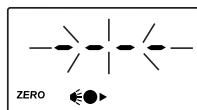

- After a few seconds the display will show “-0.0-”. The meter is now zeroed and ready for measurement

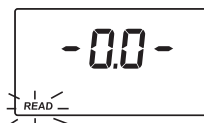

- Remove the cuvet from the instrument and open the cap.

- Add 6 drops of HI 83748B-0 reagent B to the cuvet.

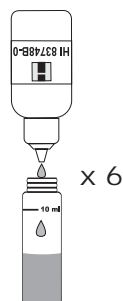

- Replace the cap and shake gently to mix.

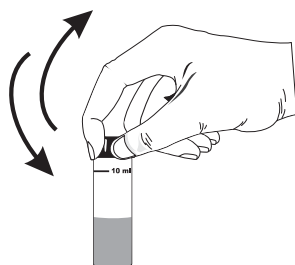

- Reinsert the cuvet into the instrument and close the lid.

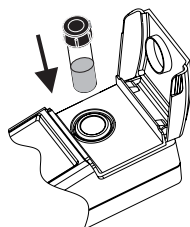

A microprocessor controlled special tungsten lamp emits radiation which is first optically conditioned and beamed to the sample contained in the cuvet. The optical path is fixed by the diameter of the cuvet. Then the light is spectrally filtered to a narrow spectral bandwidth, to obtain a light beam of intensity I_0 or I .

The photoelectric cell collects the radiation I that is not absorbed by the sample and converts it into an electric current, producing a potential in the mV range.

The microprocessor uses this potential to convert the incoming value into the desired measuring unit and to display it on the LCD.

The measurement process is carried out in two phases: first the meter is zeroed and then the actual measurement is performed.

The cuvet has a very important role because it is an optical element and thus requires particular attention. It is important that both the measurement and the calibration (zeroing) cuvet are optically identical to provide the same measurement conditions. Whenever possible use the same cuvet for both. It is necessary that the surface of the cuvet is clean and not scratched. This to avoid measurement interference due to unwanted reflection and absorption of light. It is recommended not to touch the cuvet walls with hands.

Furthermore, in order to maintain the same conditions during the zeroing and the measuring phases, it is necessary to close the cuvet to prevent any contamination.

ABBREVIATIONS

EPA: US Environmental Protection Agency

°C: degree Celsius

°F: degree Fahrenheit

mg/L: milligrams per liter. mg/L is equivalent to ppm (part per million)

mL: milliliter

LCD: Liquid Crystal Display

FUNCTIONAL DESCRIPTION

INSTRUMENT DESCRIPTION

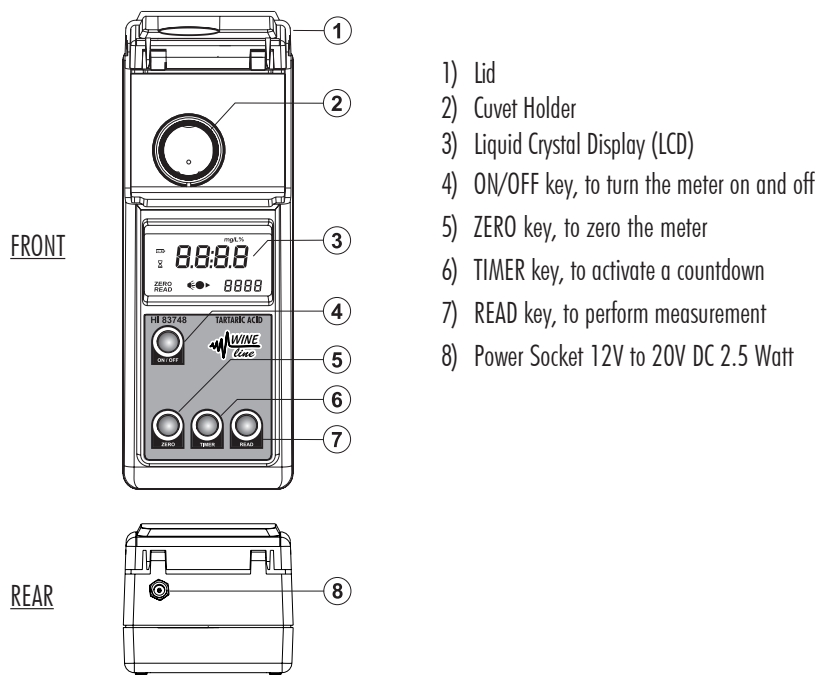

- 1) Lid
- 2) Cuvet Holder
- 3) Liquid Crystal Display (LCD)
- 4) ON/OFF key, to turn the meter on and off
- 5) ZERO key, to zero the meter
- 6) TIMER key, to activate a countdown
- 7) READ key, to perform measurement
- 8) Power Socket 12V to 20V DC 2.5 Watt

DISPLAY ELEMENTS DESCRIPTION

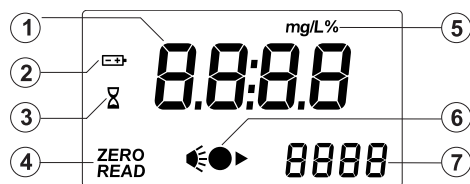

- 1) Four digit main display.
- 2) Battery icon: appears when the battery voltage is getting low.
- 3) The hourglass icon: appears during the countdown.
- 4) Status information.
- 5) Measurement unit.
- 6) Lamp status indicator.
- 7) Four digit secondary display.

MEASUREMENT PROCEDURE

- Turn the instrument on by pressing ON/OFF.
- When the LCD displays "---", it is ready.

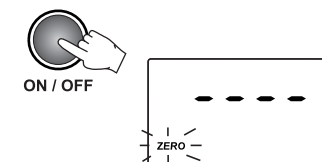

- Use the 200 μ L automatic pipette to add exactly 0,2 mL of wine sample to an empty cuvet.

For a correct use of the automatic pipette please follow the related Instruction Sheet.



- Use the 5 mL syringe to add exactly 5 mL of HI 83748A-0 reagent A.

Note: in order to measure exactly 5 mL of reagent with the syringe, follow the instructions on page 11.

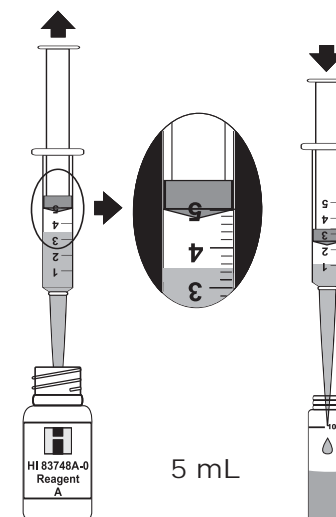

- Close the cuvet and shake gently for some seconds.

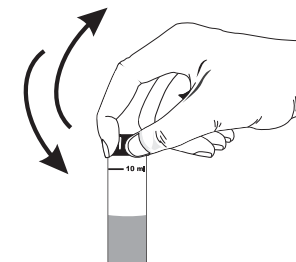

- Proper use of the dropper:
 - (a) to get good reproducible results, tap the dropper on the table for several times and wipe the outside of the dropper tip with a cloth.
 - (b) always keep the dropper bottle in a vertical position while dosing the reagent.

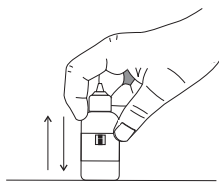

(a)

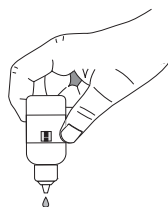

(b)

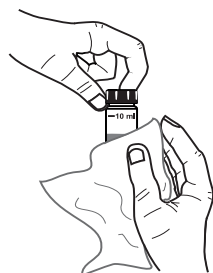

- Whenever the cuvet is placed into the measurement cell, it must be dry outside, and completely free of fingerprints, oil or dirt. Wipe it thoroughly with **HI 731318** (tissue for wiping cuvet, see chapter ACCESSORIES) or a lint-free cloth prior to insertion.
- Do not let the reacted sample stand too long after reaction, or accuracy will be lost.
- After the reading it is important to discard immediately the sample, otherwise the glass might become permanently stained.
- All the reaction times reported in this manual are referred to 20°C (68°F). As a general rule of thumb, they should be doubled at 10°C (50°F) and halved at 30°C (86°F).

GUIDE TO DISPLAY CODES



This prompt appears for a few seconds each time the instrument is turned ON.

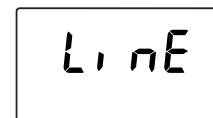

These prompts indicate the type of power supply: "Line" (if the external power supply is used) or the battery level.

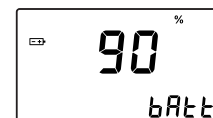

Indicates that the instrument is in a ready state and waiting for the next command (Timer or Zero).

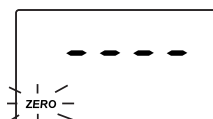

After Timer is pressed, a blinking hourglass icon appears and the display shows a 60 minutes countdown. Also the Zero tag might blink if no zero measurement has been made before. At the end an acoustic signal alerts the user that the countdown has finished.

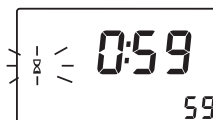

Indicates that the meter is performing a zero measurement. The light intensity is automatically re-adjusted (auto-calibration features) if necessary.

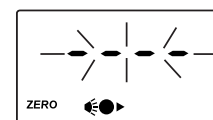

The instrument is zeroed and a measurement can be made.

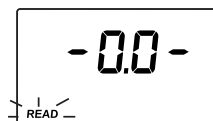

Indicates that the meter is making a measurement.

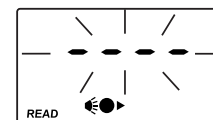

Batteries voltage is getting low and the batteries need to be replaced.

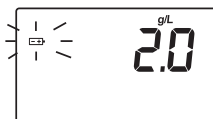

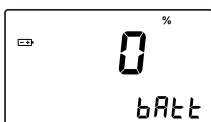

Indicates that the batteries are dead and must be replaced. After this message appears, the instrument is switched off. Change the batteries and restart the meter.



ERROR MESSAGES

The meter has lost its configuration. Contact your dealer or the nearest Hanna Customer Service Center.

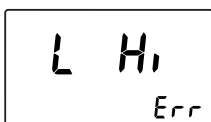

“Light high”: there is too much light to perform a measurement. Please check the preparation of the zero cuvet.

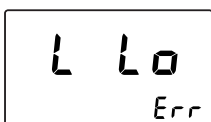

“Light low”: there is not enough light to perform a measurement. Please check the preparation of the zero cuvet.

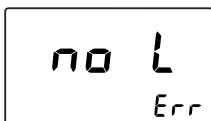

“No Light”: the lamp is not working because of a malfunction. Contact your dealer or the nearest Hanna Customer Service Center.

b) on sample reading:

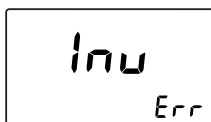

“Inverted”: the sample and the zero cuvet are inverted.



The sample absorbs less light than the zero reference. Check the procedure and make sure you use the same cuvet for reference (zero) and measurement.



A flashing value of the maximum concentration indicates an over range condition. The concentration of the sample is beyond the programmed range: dilute the sample and measure again.

GENERAL TIPS FOR AN ACCURATE MEASUREMENT

The instructions listed below should be carefully followed during testing to ensure best accuracy.

- For dosing the wine sample, we recommend to use the supplied Hanna HI 731340 automatic pipette. For a correct use of the Hanna automatic pipette, please follow the related Instruction Sheet.



- In order to avoid reagent leaking and to obtain more accurate measurements, it is recommended to close the cuvet first with the supplied HDPE plastic stopper  and then with the black cap.



- In order to measure exactly 5 mL of reagent with the 5 mL syringe:
 - push the plunger completely into the syringe and insert the tip into the reagent bottle.
 - pull the plunger up until the lower edge of the seal is exactly on the 5 mL mark.
 - take out the syringe and clean the outside of the syringe tip. Be sure that no drops are hanging on the tip of the syringe, if so eliminate them. Then, keeping the syringe in vertical position above the cuvet, push the plunger completely down into the syringe. Now the exact amount of 5 mL has been added to the cuvet.

